

RoboCylinder with Standard  
Battery-less Absolute Encoder

# RCP5 Series

**ROBO  
CYLINDER**

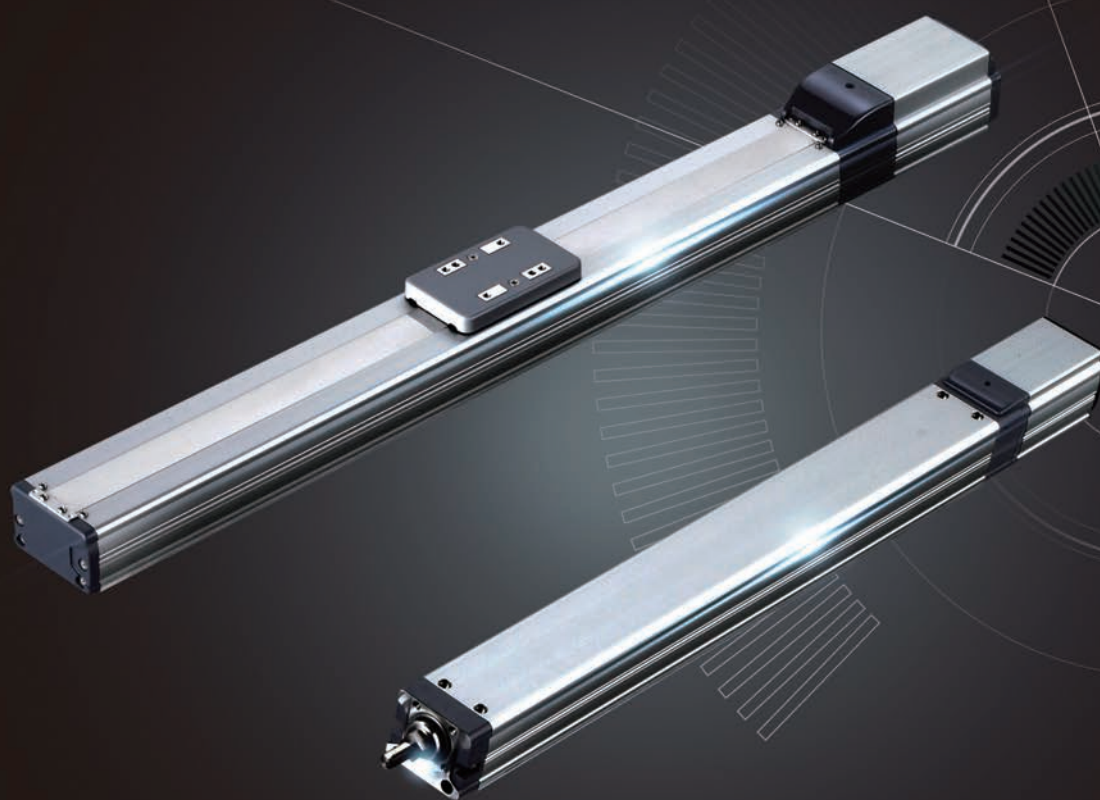

Battery Less  
**ABSOLUTE**

## Introducing the RCP5 series actuator with battery-less absolute encoder, realizing the convenience of an absolute encoder along with the cost and simplicity of an incremental encoder

The battery-less absolute encoder is an innovative encoder requiring no hassle or cost of battery replacement or adjustment associated therewith (patent pending), as rotational position data is recognized by a combination of gears to make the battery, which has been a required component of any traditional absolute encoder, no longer necessary. This encoder is ideal for the automobile industry and other production facilities where many absolute type actuators are used.

Slider type



The Industry's First

# Electric Actuator with Built-in Battery-less Absolute Encoder

Rod type



RCP5-RA7C

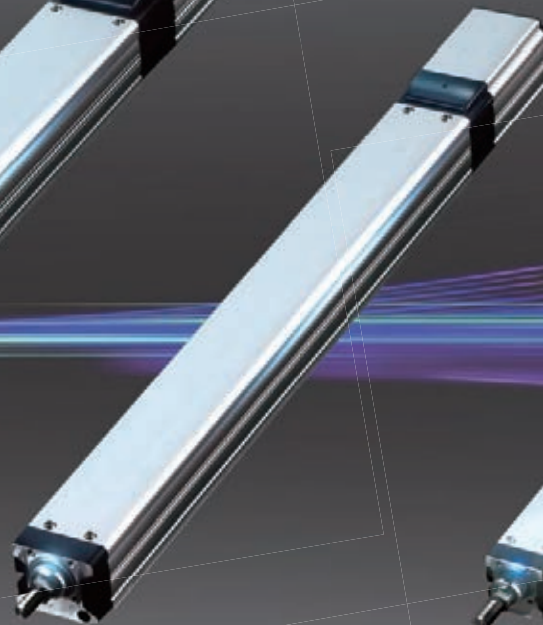

RCP5-RA6C

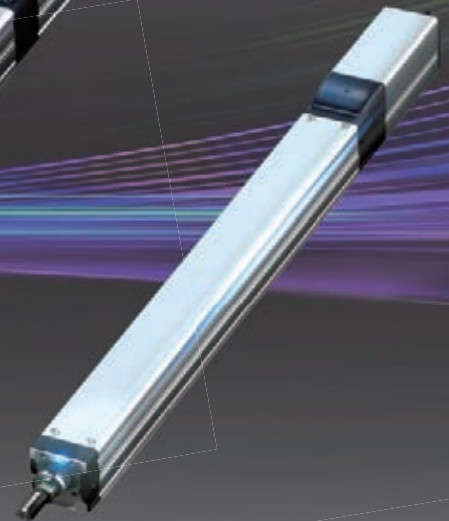

RCP5-RA4C

Controller

## Single-axis Controller PCON-CA

- Supporting the battery-less absolute encoder
- 1-axis position control
- Supporting the PowerCon
- Supporting field networks



## 6-axis controller with PLC function MSEP-LC (\*)

- Supporting the battery-less absolute encoder
- PLC function
- 6-axis position control
- Supporting the PowerCon (3 axes)
- Supporting field networks

(\*) MSEP-LC coming soon with CE conformity.



## 8-axis controller MSEP-C

- Supporting the battery-less absolute encoder
- 8-axis position control
- Supporting the PowerCon (4 axes)
- Supporting field networks

Merit **RCP5** series

**The RoboCylinder is Easy to Use!!!**

No More Problems

Shop-Floor Problems and Solutions

**Air cylinder problems**

- 1 Reduced operation rate due to choco-tei caused by the auto switch failure or air pressure fluctuations
- 2 Difficult to shorten cycle-time due to the speed limit from the shock caused by a stoppage

**Electric actuator problem (Incremental type)**

- 1 A long time is required to return to home or for an adjustment after an emergency stop is reset

**Electric actuator problem (Absolute type)**

- 1 Higher cost
- 2 Battery replacement time management is required
- 3 Battery replacement labor and cost



**Solved with an electric actuator (CT Effects)\***

- 1 Choco-tei significantly reduced
- 2 Speed increase now possible with no shock caused by a stoppage

**Solved with the absolute type**

- 1 Home return not required

**Solved with the battery-less absolute type**

- 1 Battery is not required
- 2 Slider type offered at the same price as the incremental type

**Problems solved with the RCP5 Series!**

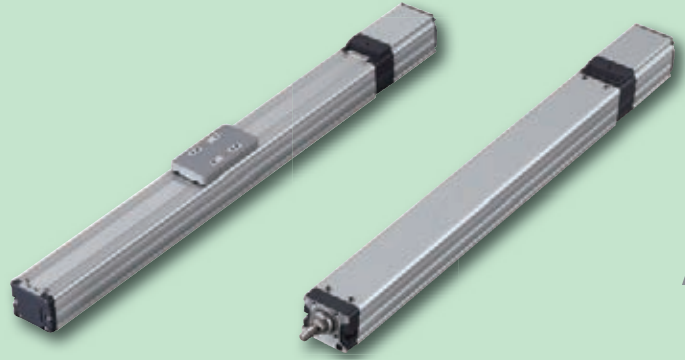

Battery-Less  
**ABSOLUTE**

\* The "CT Effects" refer to increased production output per unit time with "shorter cycle time" and "reduced choco-tei" achieved by re-examining the devices that are part of automation equipment.

Feature

1

## Battery-less absolute

### What is an absolute encoder?

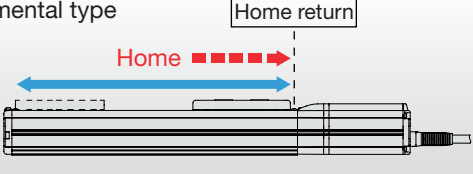
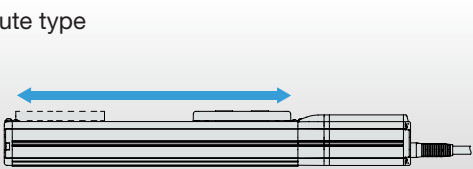
<p>Incremental type</p> 	<p>The home reference is lost when the power is shut down. This type of encoder will return to home before making a commanded move after a power cycle.</p>
<p>Absolute type</p> 	<p>With this type, position data is retained even if the power is shut down and it can be started from the current position where the power is turned on.</p>

### Advantages of an absolute encoder

**Advantage 1:**

Home return is not required, which means reduced amount of labor and time required for adjustment when starting up the device.

**Advantage 2:**

The amount of time required is reduced for adjustment to restart the device after an emergency stop.

### What is a battery-less absolute encoder?

A battery-less absolute encoder is an absolute encoder that verifies the current position based on the interlocked gear position. On conventional absolute encoders, the current position was stored in the battery. battery-less type is now available and a battery to store data is no longer required.



### Advantages of a battery-less absolute encoder

**Advantage 1:**

More economical with no cost associated with battery replacement.

**Advantage 2:**

Battery replacement management is no longer required. Labor for replacement work is also no longer required.

**Advantage 3:**

Battery installation space is not required.

**Advantage 4:**

Operation can resume with no adjustment required even when the cable between the controller and the actuator is replaced because the positional information is read each time.

**Advantage 5:**

No external sensor, such as a sensor to check the origin, is required since home return is not necessary.

**Advantage 6:**

IAI's slider type, even with the battery-less absolute encoder, is offered for the same price as the conventional incremental type.

### Service life of a battery-less absolute encoder

The mechanical configuration of the battery-less absolute encoder offers a service life that is approximately four times the actuator guide's standard rating. Furthermore, it can be used with a sense of security because it will output an error when a certain amount of wear in the gear section is detected.

Merit **RCP5** series

**The RoboCylinder is Easy to Use!!!**

Feature **2**

1.5 times higher maximum speed and double the payload when combined with a **PowerCon**

**Shorter Takt Time Significantly Boosts the Productivity of Your System**

When the new controller <PowerCon> is equipped with our newly developed high-output driver (patent pending) is used, the maximum speed increases significantly by up to 1.5 times the levels achievable with IAI's conventional models, while the payload is greater by up to twice (\*). In addition to these amazing improvements in specifications, the maximum speed does not drop as much even when the payload increases due to increased torque with the high speed motor, meaning that the dynamic performance equivalent to that of a higher-class model can be achieved at lower cost.

(\* ) The specific rates of improvement vary depending on the model.

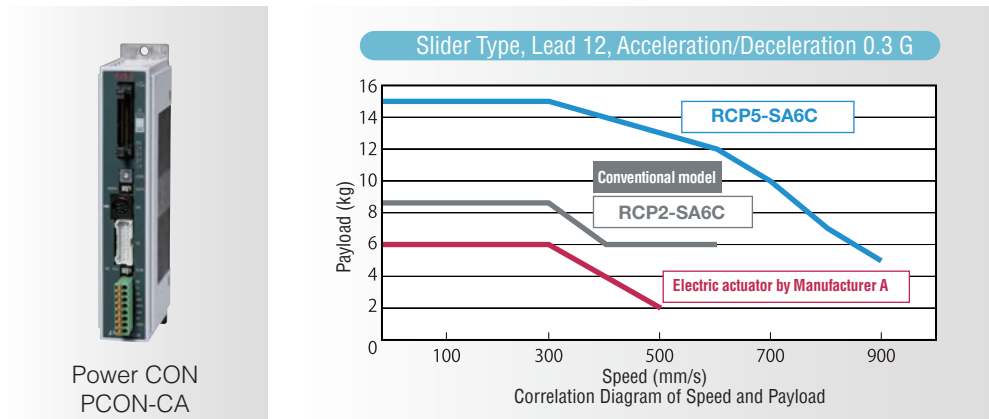

**Multi-axis type is now available with a PowerCon**

The MSEP controller, now with a PowerCon, is capable of operating the RCP5 in up to four-axis applications at high speeds 1.5 times the level achievable with the conventional models, and at a least double the dynamic payload performance. Additionally, the standard type not combined with a PowerCon can operate the RCP5 in up to eight-axis applications. Furthermore, it can move to a specified value via a field network.

RCP5 operated in up to four-axis application\*

Field network compatible

\*Eight-axis application if a PowerCon (high-output capable) is NOT used.

Feature **3**

The rod type can carry **radial loads**.

The rod type <Radial Cylinder> with a built-in guide mechanism can carry radial loads over a long stroke of up to 800mm.

The rod type <Radial Cylinder> has a built-in ball circulating type linear guide mechanism in the actuator to carry radial loads applied to the rod over a long stroke of up to 800mm. The actuator can also support a radial load applied at a position offset from the center of the rod.

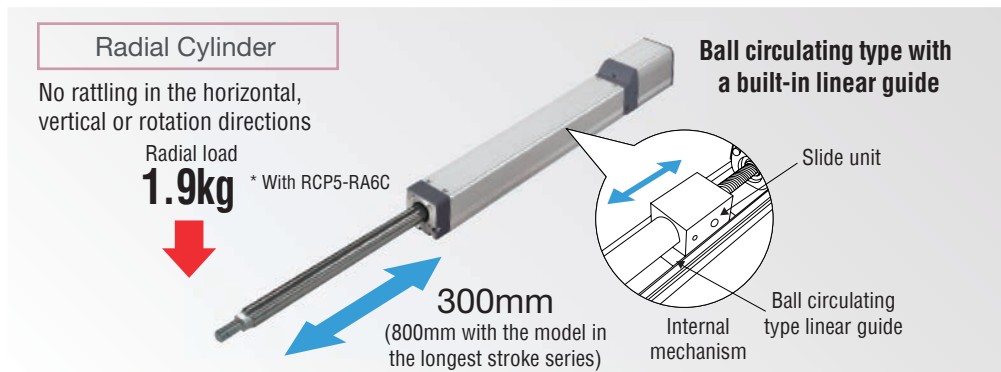

**Usage example 1** When a guide mechanism is required in a tight space

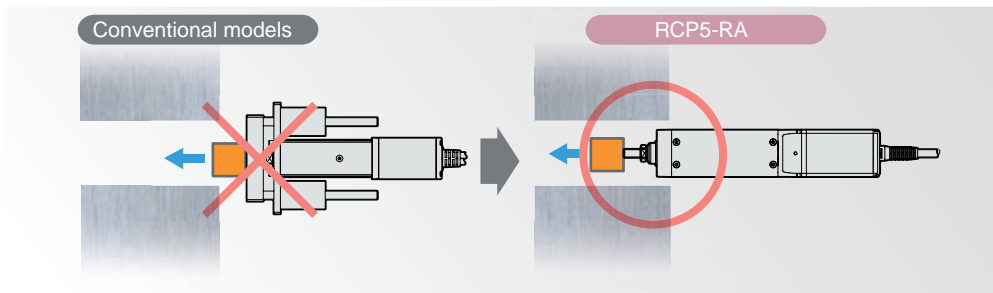

**Usage example 2** When the rod needs to be straight

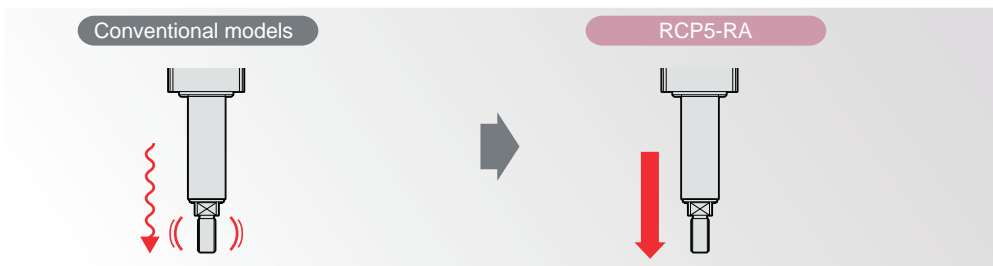

Feature **4**

Easier to Maintain

Greasing has become easier, as the ball screw and guide can be lubricated at the same time from the two grease nipples on the left and right, accessible when the frame cover is removed.

\* This feature is not available for RCP5-RA8/RA10.

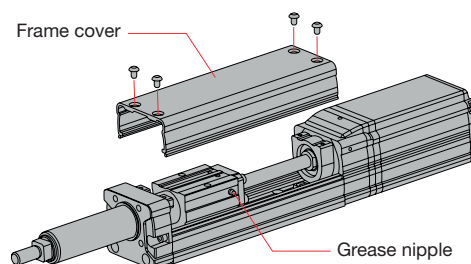

Variation **RCP5** series

**The RoboCylinder is Easy to Use!!!**



Model type

Slider type → P.11

Type	External view	Actuator width	Stroke (mm)	Ball screw lead (mm)	Maximum speed (mm/s)	Maximum payload (kg)		Page
						Horizontal	Vertical	
SA4C		 40mm	50~500	16	1260	4	1	→P.11
				10	785	10	2.25	
				5	390	12	4.5	
				2.5	195	12	9	
SA6C		 58mm	50~800	20	1440 <1280>	10	1	→P.13
				12	900	15	2.5	
				6	450	25	6	
				3	225	25	16	
SA7C		 73mm	50~800	24	1200	20	3	→P.15
				16	980 <840>	40	8	
				8	490	45	16	
				4	245 <210>	45	25	

Rod type → P.17

Type	External view	Actuator width	Stroke (mm)	Ball screw lead (mm)	Maximum speed (mm/s)	Maximum payload (kg)		Page
						Horizontal	Vertical	
RA4C		 40mm	60~410	16	1120 <840>	6	1.5	→P.17
				10	700	15	2.5	
				5	350	28	5	
				2.5	175	40	10	
RA6C		 58mm	65~415	20	800	6	1.5	→P.19
				12	700	25	4	
				6	450	40	10	
				3	225	60	20	
RA7C		 73mm	70~520	24	800 <600>	20	3	→P.21
				16	700 <560>	50	8	
				8	420	60	18	
				4	210	80	28	





**Rod type** → P.23

Model	Type	External view	Actuator width	Stroke (mm)	Ball screw lead (mm)	Maximum speed (mm/s)	Maximum payload (kg)		Page
							Horizontal	Vertical	
Straight motor specification	RA8C		 88mm	50~700	20	600 <450>	30	5	→P.23
					10	300 <250>	60	40	
					5	150	100	70	
	RA10C		 108mm	50~800	10	250 <167>	80	80	→P.25
					5	125	150	100	
					2.5	63	300	150	
Side-mounted motor specification	RA8R		 88mm	50~700	20	400	30	5	→P.27
					10	200	60	40	
					5	100	100	70	
	RA10R		 108mm	50~800	10	200 <140>	80	80	→P.29
					5	100	150	100	
					2.5	50	300	150	

**Controller** → P.39

Maximum number of connected axes	Type	External view	I/O control function	Applicable encoder	Power-supply voltage	Features	Page
1 axis	PCON-CA/CFA		—	Incremental Simple absolute Battery-less absolute	DC24V	Single-axis positioner is designed for easy control using PIOs. Common boards are used to let you operate the range of actuators from RCP2 through RCP5 with the same controller by simply changing the parameters.	→P.39
8 axes	MSEP-C		—			8-axis positioner is designed for easy control using PIOs. A combination of pulse motor, AC servo motor and DC servo motor actuators can be operated with one controller.	→P.47
6 axes	MSEP-LC (*)		○			The I/O control function supports standalone operation and control of peripheral equipment.	

(\*) MSEP-LC coming soon with CE conformity.

# Models/Options **RCP5** series

**The RoboCylinder is Easy to Use!!!**

Model Specification Items

## Model Specification Items

<Slider type>

**RCP5** —  — **WA** —  —  —  — **P3** —  —

Series      Type      Encoder type      Motor type      Ball screw lead      Stroke      Applicable controller      Cable length      Options

SA4C	Actuator width: 40mm Coupling type	35P	35 frame pulse motor	2.5	2.5mm	P3	PCON-CA MSEP	B	Brake
SA6C	Actuator width: 58mm Coupling type	42P	42 frame pulse motor	3	3mm			N	None
SA7C	Actuator width: 73mm Coupling type	56P	56 frame pulse motor	4	4mm	P	1m		
				5	5mm	S	3m		
				6	6mm	M	5m		
				8	8mm	X <input type="checkbox"/>	Specified length		
				10	10mm	R <input type="checkbox"/>	Robot cable		
				12	12mm				
				16	16mm				
				20	20mm				
				24	24mm				

(Can be set in 50mm increments)

\* The available selections for encoder type, motor type, ball screw lead and stroke vary depending on the actuator type. For details, refer to the page featuring each actuator type.

<Rod type RA4/RA6/RA7>

**RCP5** —  — **WA** —  —  —  — **P3** —  —

Series      Type      Encoder type      Motor type      Ball screw lead      Stroke      Applicable controller      Cable length      Options

RA4C	Actuator width: 40mm Coupling type	35P	35 frame pulse motor	50	50mm	P3	PCON-CA MSEP	B	Brake
RA6C	Actuator width: 58mm Coupling type	42P	42 frame pulse motor	5	5mm			N	None
RA7C	Actuator width: 73mm Coupling type	56P	56 frame pulse motor	520	520mm	P	1m	FFA	Tip adapter (Flange)
						S	3m	NFA	Tip adapter (Internal Thread)
						M	5m	KFA	Tip adapter (Keyway)
						X <input type="checkbox"/>	Specified length	NM	Non-motor end specification
						R <input type="checkbox"/>	Robot cable		

(Can be set in 50mm increments)

\* The available selections for encoder type, motor type, ball screw lead and stroke vary depending on the actuator type. For details, refer to the page featuring each actuator type.

<Rod type RA8/RA10>

**RCP5** —  — **WA** —  —  —  — **P4** —  —

Series      Type      Encoder type      Motor type      Ball screw lead      Stroke      Applicable controller      Cable length      Options

RA8C	Actuator width: 88mm Coupling type	60P	60 frame pulse motor	50	50mm	P4	PCON-CFA	B	Brake
RA10C	Actuator width: 108mm Coupling type	86P	86 frame pulse motor	5	5mm			N	None
RA8R	Actuator width: 84mm Side-mounted motor type			800	800mm	P	1m	CJR	Optional cable exit direction (right)
RA10R	Actuator width: 108mm Side-mounted motor type					S	3m	CJL	Optional cable exit direction (left)
						M	5m	CJO	Optional cable exit direction (outside)
						X <input type="checkbox"/>	Specified length	CJB	Optional cable exit direction (bottom)
						R <input type="checkbox"/>	Robot cable	FL	Flange
								ML	Motor side-mounted to the left (standard)
								MR	Motor side-mounted to the right
								NM	Non-motor end specification

(Can be set in 50mm increments)

\* The available selections for encoder type, motor type, ball screw lead and stroke vary depending on the actuator type. For details, refer to the page featuring each actuator type.

Option

# Actuator Options

<p><b>Brake</b> Option code: B</p>	<p><b>Applicable models</b> All models</p> <p><b>Description</b> A mechanism that is used to hold the slider or rod in place when the actuator is used vertically, so that it will not drop and damage the work part, etc., when the power or servo is turned off.</p>
<p><b>Optional cable exit direction</b> Option code: CJT CJR CJL CJB CJO</p>	<p><b>Applicable models</b> RCP5-RA8C/RA10C/RA8R/RA10R</p> <p><b>Description</b> Select this option if you want to change the exit direction of the motor/encoder cables to the top, bottom, left or right.</p> <div style="display: flex; justify-content: space-around;"> <div data-bbox="488 656 922 965"> <p><b>Motor coupled type</b></p> <p>* View from the rear of the actuator (motor side)</p> </div> <div data-bbox="962 656 1396 965"> <p><b>Side-mounted motor type</b></p> <p>* View from the front of the actuator</p> </div> </div>
<p><b>Side-mounted motor direction</b> Option code: ML/MR</p> <p>* Be sure to specify either "ML" or "MR" for the side-mounted motor type.</p>	<p><b>Applicable models</b> RCP5-RA8R/RA10R</p> <p><b>Description</b> The side-mounted motor direction can be specified. ML and MR represent the left and right, respectively, as viewed from the motor side of the actuator.</p> <div style="display: flex; justify-content: space-around;"> <div data-bbox="488 1126 922 1312"> <p>The motor is side-mounted to the left (standard) Option code: ML</p> </div> <div data-bbox="962 1126 1396 1312"> <p>The motor is side-mounted to the right Option code: MR</p> </div> </div>
<p><b>Non-motor end specification</b> Option code: NM</p>	<p><b>Applicable models</b> All models</p> <p><b>Description</b> Select this option if you want to change the home position of the actuator's slider or rod from the normal position (the motor end) to the front end.</p>
<p><b>Flange</b> Option code: FL</p>	<p><b>Applicable models</b> RCP5-RA4C/RA6C/RA7C/RA8C/RA8R/RA10C/RA10R</p> <p><b>Description</b> A bracket that is used to secure a rod actuator from the actuator side. The flange can be purchased separately later. * For dimensions on each model, check on P. 59.</p>
<p><b>Tip Adapter (Flange)</b> Option code: FFA</p>	<p><b>Applicable models</b> RCP5-RA4C/RA6C/RA7C</p> <p><b>Description</b> An adapter that is used to install jigs, etc. on the rod tip using four bolts. * For dimensions on each model, check on P. 59.</p>
<p><b>Tip Adapter (Internal thread)</b> Option code: NFA</p>	<p><b>Applicable models</b> RCP5-RA4C/RA6C/RA7C</p> <p><b>Description</b> An adapter that is used to install jigs, etc. on the rod tip using a bolt. * For dimensions on each model, check on P. 60.</p>
<p><b>Tip Adapter (Keyway)</b> Option code: KFA</p>	<p><b>Applicable models</b> RCP5-RA4C/RA6C/RA7C</p> <p><b>Description</b> An adapter that is used to install jigs, etc. on the rod tip using a bolt and parallel key. * For dimensions on each model, check on P. 60.</p>

# RCP5-SA4C

RoboCylinder, Slider Type, Motor Unit Coupled, Actuator Width 40mm, 24-V Pulse Motor

Model Specification Items	<b>RCP5</b> — <b>SA4C</b> — <b>WA</b> — <b>35P</b> — <input type="checkbox"/> — <input type="checkbox"/> — <input type="checkbox"/> — <input type="checkbox"/> — <input type="checkbox"/> — <input type="checkbox"/>			<b>P3</b> — <input type="checkbox"/> — <input type="checkbox"/>					
	Series	Type	Encoder type	Motor type	Lead	Stroke	Applicable controller	Cable length	Options
			WA : Battery-less absolute specification	35P : Pulse motor, size 35 <input type="checkbox"/>	16 : 16mm 10 : 10mm 5 : 5mm 2.5 : 2.5mm	50 : 50mm 500 : 500mm (every 50mm)	P3 : PCON-CA MSEP-C/LC	N : None P : 1m S : 3m M : 5m X <input type="checkbox"/> : Specified length R <input type="checkbox"/> : Robot cable	Refer to the options table below.



### Correlation Diagrams of Speed and Payload

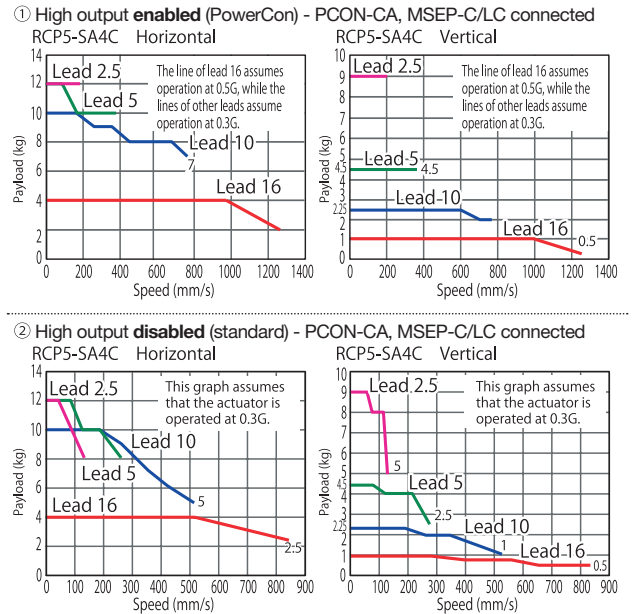

**POINT**  
Note on selection

(1) The payload in "Actuator Specifications" represents the maximum values, but the payload of a specific model varies depending on the acceleration. For details, refer to "Selection Guideline" (Table of RCP5 Payload by Speed/Acceleration) on pp. 33 to 34.

(2) Refer to P. 31 for the push-motion operation.

### Actuator Specifications

#### Lead and Payload

Model number	Lead (mm)	High output setting	Maximum payload		Stroke (mm)
			Horizontal (kg)	Vertical (kg)	
RCP5-SA4C-WA-35P-16-①-P3-②-③	16	Enabled	4	1	50-500 (every 50mm)
		Disabled			
RCP5-SA4C-WA-35P-10-①-P3-②-③	10	Enabled	10	2.25	
		Disabled			
RCP5-SA4C-WA-35P-5-①-P3-②-③	5	Enabled	12	4.5	
		Disabled			
RCP5-SA4C-WA-35P-2.5-①-P3-②-③	2.5	Enabled	12	9	
		Disabled			

Code explanation ① Stroke ② Cable length ③ Options

#### Stroke and Maximum Speed

(unit: mm/s)

Lead (mm)	High output setting	50-400 (every 50mm)		
		450 (mm)	500 (mm)	500 (mm)
16	Enabled	1260	1060	875
	Disabled	840		
10	Enabled	785	675	555
	Disabled	525		
5	Enabled	390	330	275
	Disabled	260		
2.5	Enabled	195	165	135
	Disabled	130		

### Cable Length

Type	Cable symbol
Standard type	P(1m)
	S(3m)
	M(5m)
Special length	X06(6m) ~ X10(10m)
	X11(11m) ~ X15(15m)
	X16(16m) ~ X20(20m)
	R01(1m) ~ R03(3m)
Robot cable	R04(4m) ~ R05(5m)
	R06(6m) ~ R10(10m)
	R11(11m) ~ R15(15m)
	R16(16m) ~ R20(20m)

### Option

Name	Option code	See page
Brake	B	→P.10
Non-motor end specification	NM	

### Actuator Specifications

Item	Description
Drive system	Ball screw ø8mm, rolled C10
Positioning repeatability	±0.02mm
Lost motion	0.1 mm or less
Base	Material: Aluminum with white alumite treatment
Guide	Linear guide
Dynamic allowable moment (*1)	Ma: 3.9 Nm, Mb: 5.5 Nm, Mc: 7.5 Nm
Allowable overhang	120mm or less in Ma, Mb and Mc directions
Ambient operating temperature, humidity	0 to 40°C, 85% RH or less (Non-condensing)

(\*1) Based on 5000km of traveling life

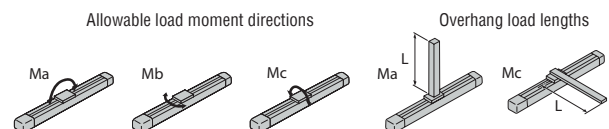

Dimensional Drawings

CAD drawings can be downloaded from the website. [www.robocylinder.de](http://www.robocylinder.de)



\*1 During home return, be careful to avoid interference from peripheral objects because the slider travels until the mechanical end.  
ME: Mechanical end  
SE: Stroke end

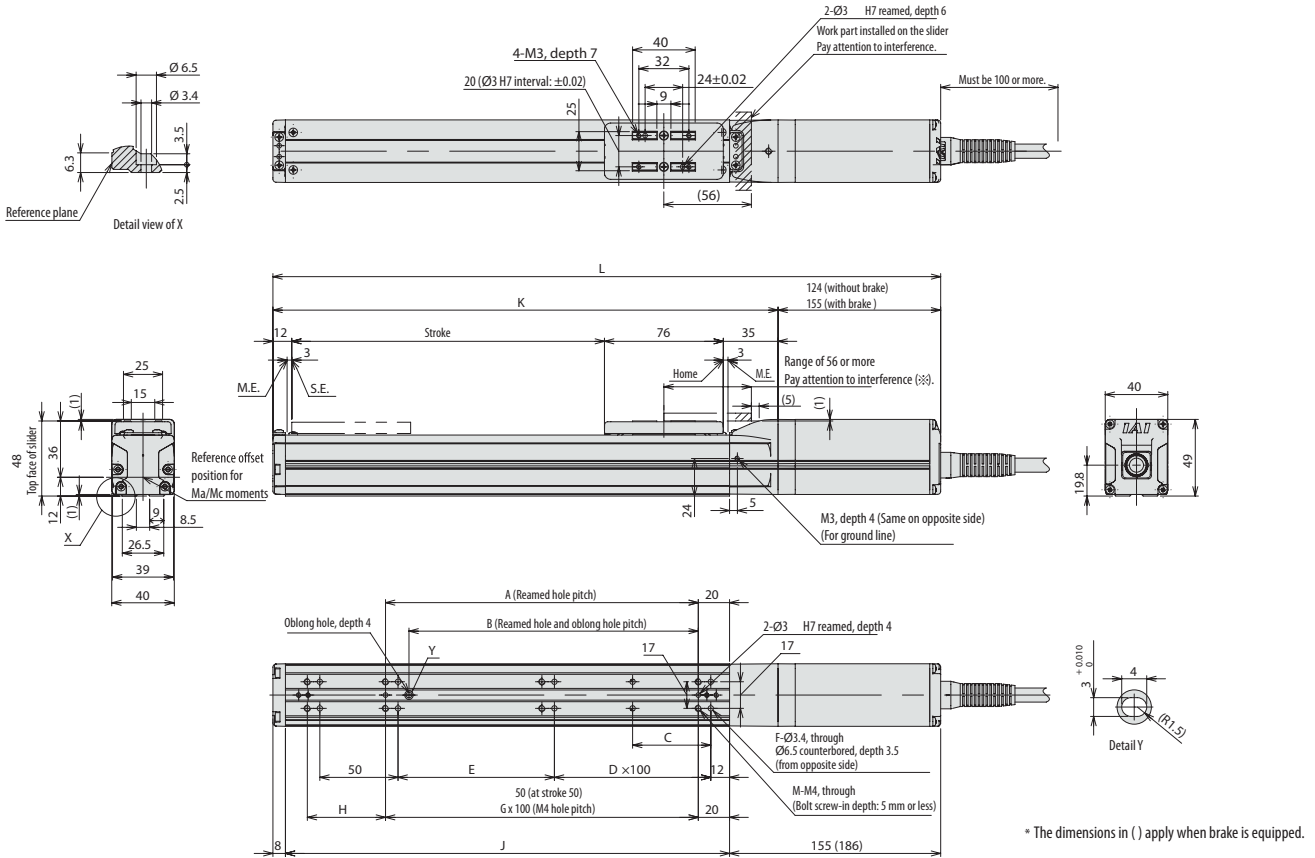

\* The dimensions in ( ) apply when brake is equipped.

Dimensions and Mass by Stroke

Stroke	50	100	150	200	250	300	350	400	450	500	
L	Without brake	297	347	397	447	497	547	597	647	697	747
	With brake	328	378	428	478	528	578	628	678	728	778
A	50	100	100	200	200	300	300	400	400	500	
B	35	85	85	185	185	285	285	385	385	485	
C	25	50	50	50	50	50	50	50	50	50	
D	0	0	1	1	2	2	3	3	4	4	
E	50	100	50	100	50	100	50	100	50	100	
F	8	8	10	10	12	12	14	14	16	16	
G	-	1	1	2	2	3	3	4	4	5	
H	50	50	100	50	100	50	100	50	100	50	
J	134	184	234	284	334	384	434	484	534	584	
K	173	223	273	323	373	423	473	523	573	623	
M	6	6	6	8	8	10	10	12	12	14	
Mass (kg)	Without brake	1.0	1.1	1.2	1.3	1.3	1.4	1.5	1.6	1.7	1.8
	With brake	1.2	1.3	1.4	1.5	1.5	1.6	1.7	1.8	1.9	2.0

Applicable Controller

RCP5 series actuators can be operated with the controller indicated below. Select the type according to your intended application.

Name	External view	Model number	Features	Maximum number of positioning points	Input power	Power supply capacity	Reference page
Positioner type		PCON-CA-35PWAI-NP-□-0-□ PCON-CA-35PWAI-PN-□-0-□	Equipped with a high-output driver Positioner type based on PIO control	512 points	DC24V	Refer to P. 46	Refer to P. 39
Pulse-train type		PCON-CA-35PWAI-PLN-□-0-□ PCON-CA-35PWAI-PLP-□-0-□	Equipped with a high-output driver Pulse-train input type	—			
Field network type		PCON-CA-35PWAI-①-0-0-□	Equipped with a high-output driver Supporting major field networks	768 points			
Position controller, 8-axis type		MSEP-C-□-35PWAI-□-□-0	Positioner type that accepts connection of up to eight axes.	3 points/256 points	Refer to P. 55	Refer to P. 47	
6-axis type with I/O control function		MSEP-LC-□-35PWAI-□-□-0-□ (*) (*) MSEP-LC coming soon with CE conformity.	Axes can be moved and I/O signal turned ON/OFF using a ladder logic program.	256 points			

\* In the model numbers shown above, ① indicates the field network specification (DV, CC, PR, CN, PRT, EC or EP).

# RCP5-SA6C

RoboCylinder, Slider Type, Motor Unit Coupled, Actuator Width 58mm, 24-V Pulse Motor

Model Specification Items	<b>RCP5</b> — <b>SA6C</b> — <b>WA</b> — <b>42P</b> — <input type="checkbox"/> — <input type="checkbox"/> — <b>P3</b> — <input type="checkbox"/> — <input type="checkbox"/>
	Series — Type — Encoder type — Motor type — Lead — Stroke — Applicable controller — Cable length — Options
	WA : Battery-less absolute specification 42P : Pulse motor, size 42 <input type="checkbox"/> 20 : 20mm 12 : 12mm 6 : 6mm 3 : 3mm 50 : 50mm 800 : 800mm (every 50mm) P3 : PCON-CA MSEP-C/LC N : None P : 1m S : 3m M : 5m X <input type="checkbox"/> : Specified length R <input type="checkbox"/> : Robot cable Refer to the options table below.



**POINT**  
Note on selection

(1) The payload in "Actuator Specifications" represents the maximum values, but the payload of a specific model varies depending on the acceleration. For details, refer to "Selection Guideline" (Table of RCP5 Payload by Speed/Acceleration) on pp. 33 to 34.  
(2) Refer to P. 31 for the push-motion operation.

### Correlation Diagrams of Speed and Payload

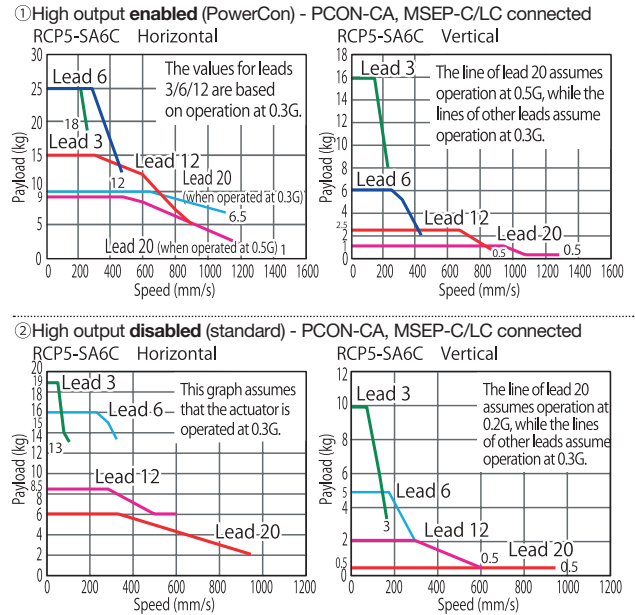

### Actuator Specifications

#### Lead and Payload

Model number	Lead (mm)	High output setting	Maximum payload		Stroke (mm)
			Horizontal (kg)	Vertical (kg)	
RCP5-SA6C-WA-42P-20-①-P3-②-③	20	Enabled	10	1	50-800 (every 50mm)
		Disabled	6	0.5	
RCP5-SA6C-WA-42P-12-①-P3-②-③	12	Enabled	15	2.5	
		Disabled	8.5	2	
RCP5-SA6C-WA-42P-6-①-P3-②-③	6	Enabled	25	6	
		Disabled	16	5	
RCP5-SA6C-WA-42P-3-①-P3-②-③	3	Enabled	25	16	
		Disabled	19	10	

Code explanation ① Stroke ② Cable length ③ Options

#### Stroke and Maximum Speed

The values in <> apply when the actuator is used vertically. (unit: mm/s)

Lead (mm)	High output setting	Maximum speed (mm/s)									
		50-400 (every 50mm)	450 (mm)	500 (mm)	550 (mm)	600 (mm)	650 (mm)	700 (mm)	750 (mm)	800 (mm)	
20	Enabled	1440 (<1280>)	1335 (<1280>)	1130	970	840	735	650	575		
	Disabled	960						840	735	650	575
12	Enabled	900	885	735	620	535	460	405	355	315	
	Disabled	600			535	460	405	355	315		
6	Enabled	450	435	365	305	265	230	200	175	155	
	Disabled	300			265	230	200	175	155		
3	Enabled	225	215	180	150	130	115	100	85	75	
	Disabled	150		130	115	100	85	75			

### Cable Length

Type	Cable symbol
Standard type	P(1m)
	S(3m)
	M(5m)
Special length	X06(6m) ~ X10(10m)
	X11(11m) ~ X15(15m)
	X16(16m) ~ X20(20m)
Robot cable	R01(1m) ~ R03(3m)
	R04(4m) ~ R05(5m)
	R06(6m) ~ R10(10m)
	R11(11m) ~ R15(15m)
	R16(16m) ~ R20(20m)

### Option

Name	Option code	See page
Brake	B	→P.10
Non-motor end specification	NM	

### Actuator Specifications

Item	Description
Drive system	Ball screw $\phi$ 10mm, rolled C10
Positioning repeatability (*1)	$\pm 0.02$ mm [ $\pm 0.03$ ]
Lost motion	0.1mm or less
Base	Material: Aluminum with white alumite treatment
Guide	Linear guide
Dynamic allowable moment (*2)	Ma: 8.9 Nm, Mb: 12.7 Nm, Mc: 18.6 Nm
Allowable overhang	150mm or less in Ma, Mb and Mc directions
Ambient operating temperature, humidity	0 to 40°C, 85% RH or less (Non-condensing)

(\*1) The value at lead 20 is shown in [ ].

(\*2) Based on 5000km of traveling life

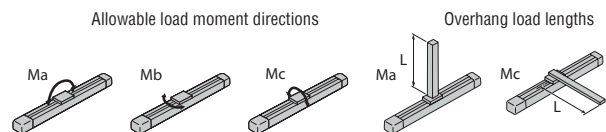

Dimensional Drawings

CAD drawings can be downloaded from the website: [www.robocylinder.de](http://www.robocylinder.de)



\*1 During home return, be careful to avoid interference from peripheral objects because the slider travels until the mechanical end.  
ME: Mechanical end  
SE: Stroke end

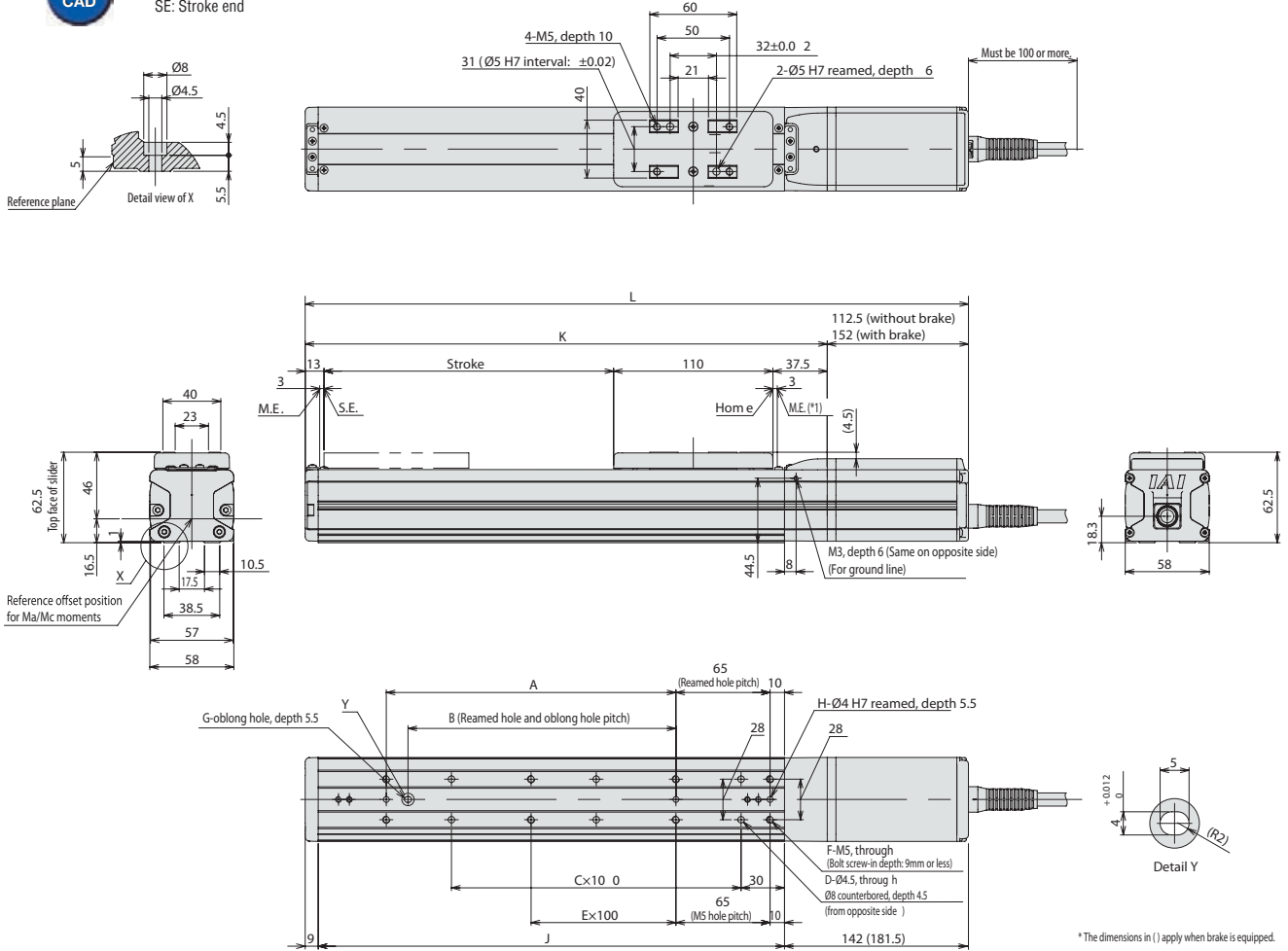

Dimensions and Mass by Stroke

Stroke	50	100	150	200	250	300	350	400	450	500	550	600	650	700	750	800	
L	Without brake	323	373	423	473	523	573	623	673	723	773	823	873	923	973	1023	1073
	With brake	362.5	412.5	462.5	512.5	562.5	612.5	662.5	712.5	762.5	812.5	862.5	912.5	962.5	1012.5	1062.5	1112.5
A	0	100	100	200	200	300	300	400	400	500	500	600	600	700	700	800	
B	0	85	85	185	185	285	285	385	385	485	485	585	585	685	685	785	
C	1	1	2	2	3	3	4	4	5	5	6	6	7	7	8	8	
D	4	4	6	6	8	8	10	10	12	12	14	14	16	16	18	18	
E	0	0	0	1	1	2	2	3	3	4	4	5	5	6	6	7	
F	4	6	6	8	8	10	10	12	12	14	14	16	16	18	18	20	
G	0	1	1	1	1	1	1	1	1	1	1	1	1	1	1	1	
H	2	3	3	3	3	3	3	3	3	3	3	3	3	3	3	3	
J	172	222	272	322	372	422	472	522	572	622	672	722	772	822	872	922	
K	210.5	260.5	310.5	360.5	410.5	460.5	510.5	560.5	610.5	660.5	710.5	760.5	810.5	860.5	910.5	960.5	
Mass (kg)	Without brake	1.7	1.8	2.0	2.2	2.4	2.5	2.7	2.9	3.1	3.2	3.4	3.6	3.8	3.9	4.1	4.3
	With brake	1.9	2.0	2.2	2.4	2.6	2.7	2.9	3.1	3.3	3.4	3.6	3.8	4.0	4.1	4.3	4.5

Applicable Controller

RCP5 series actuators can be operated with the controller indicated below. Select the type according to your intended application.

Name	External view	Model number	Features	Maximum number of positioning points	Input power	Power supply capacity	Reference page
Positioner type		PCON-CA-42PWAI-NP-□□-□□ PCON-CA-42PWAI-PN-□□-□□	Equipped with a high-output driver Positioner type based on PIO control	512 points	DC24V	Refer to P. 46	Refer to P. 39
Pulse-train type		PCON-CA-42PWAI-PLN-□□-□□ PCON-CA-42PWAI-PLP-□□-□□	Equipped with a high-output driver Pulse-train input type	—			
Field network type		PCON-CA-42PWAI-□□-□□-□□	Equipped with a high-output driver Supporting major field networks	768 points			
Position controller, 8-axis type		MSEP-C-□□-42PWAI-□□-□□-□□	Positioner type that accepts connection of up to eight axes.	3 points/256 points			
6-axis type with I/O control function		MSEP-LC-□□-42PWAI-□□-□□-□□ (*) (*) MSEP-LC coming soon with CE conformity.	Axes can be moved and I/O signal turned ON/OFF using a ladder logic program.	256 points			

\* In the model numbers shown above, □ indicates the field network specification (DV, CC, PR, CN, PRT, EC or EP).

# RCP5-SA7C

RoboCylinder, Slider Type, Motor Unit Coupled, Actuator Width 73mm, 24-V Pulse Motor

Model Specification Items	<b>RCP5</b> — <b>SA7C</b> — <b>WA</b> — <b>56P</b> — <input type="checkbox"/> — <input type="checkbox"/> — <b>P3</b> — <input type="checkbox"/> — <input type="checkbox"/>	Series — Type — Encoder type — Motor type — Lead — Stroke — Applicable controller — Cable length — Options			
	WA : Battery-less absolute specification 56P : Pulse motor, size 56 <input type="checkbox"/>	24 : 24mm 16 : 16mm 8 : 8mm 4 : 4mm	50 : 50mm 800 : 800mm (every 50mm)	P3 : PCON-CA MSEP-C/LC	N : None P : 1m S : 3m M : 5m X <input type="checkbox"/> : Specified length R <input type="checkbox"/> : Robot cable



**POINT**  
Note on selection

(1) The payload in "Actuator Specifications" represents the maximum values, but the payload of a specific model varies depending on the acceleration. For details, refer to "Selection Guideline" (Table of RCP5 Payload by Speed/Acceleration) on pp. 33 to 34.  
(2) Refer to P. 31 for the push-motion operation.

### Correlation Diagrams of Speed and Payload

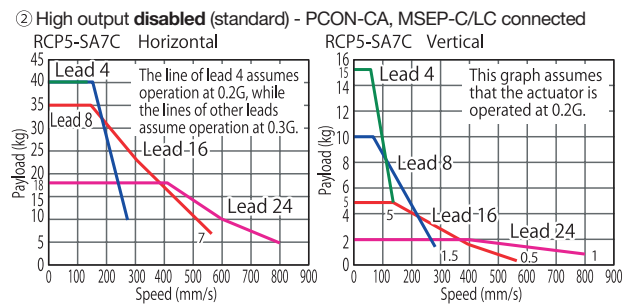
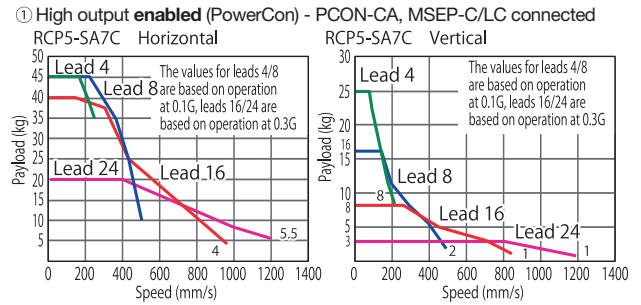

### Actuator Specifications

#### Lead and Payload

Model number	Lead (mm)	High output setting	Max. payload		Stroke (mm)
			Horizontal (kg)	Vertical (kg)	
RCP5-SA7C-WA-56P-24-①-P3-②-③	24	Enabled	20	3	50~800 (every 50mm)
		Disabled	18	2	
RCP5-SA7C-WA-56P-16-①-P3-②-③	16	Enabled	40	8	
		Disabled	35	5	
RCP5-SA7C-WA-56P-8-①-P3-②-③	8	Enabled	45	16	
		Disabled	40	10	
RCP5-SA7C-WA-56P-4-①-P3-②-③	4	Enabled	45	25	
		Disabled	40	15	

Code explanation ① Stroke ② Cable length ③ Options

#### Stroke and Maximum Speed

The values in <> apply when the actuator is used vertically. (unit: mm/s)

Lead (mm)	High output setting	50~550	600	650	700	750	800
		(every 50mm)	(mm)	(mm)	(mm)	(mm)	(mm)
24	Enabled	1200	1145	1000	885	785	
	Disabled		800				785
16	Enabled	980 <840>	875 <840>	755	660	585	520
	Disabled		560				520
8	Enabled	490	430	375	325	290	255
	Disabled		280				255
4	Enabled	245 <210>	215 <210>	185	160	140	125
	Disabled		140				125

#### Cable Length

Type	Cable symbol
Standard type	P(1m)
	S(3m)
	M(5m)
Special length	X06(6m) ~ X10(10m)
	X11(11m) ~ X15(15m)
	X16(16m) ~ X20(20m)
	R01(1m) ~ R03(3m)
Robot cable	R04(4m) ~ R05(5m)
	R06(6m) ~ R10(10m)
	R11(11m) ~ R15(15m)
	R16(16m) ~ R20(20m)

#### Option

Name	Option code	See page
Brake	B	→P.10
Non-motor end specification	NM	

#### Actuator Specifications

Item	Description
Drive system	Ball screw $\phi$ 12mm, rolled C10
Positioning repeatability (*1)	$\pm 0.02$ mm [ $\pm 0.03$ ]
Lost motion	0.1mm or less
Base	Material: Aluminum with white alumite treatment
Guide	Linear guide
Dynamic allowable moment (*2)	Ma: 10 Nm, Mb: 14.2 Nm, Mc: 28.8 Nm
Allowable overhang	230mm or less in Ma, Mb and Mc directions
Ambient operating temperature, humidity	0 to 40°C, 85% RH or less (Non-condensing)

(\*1) The value at lead 24 is shown in [ ].  
(\*2) Based on 5,000km of traveling life

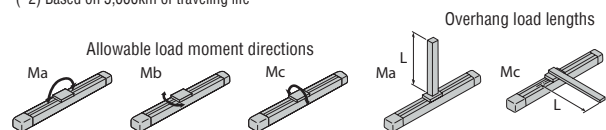



Dimensional Drawings

CAD drawings can be downloaded from the website. [www.robocylinder.de](http://www.robocylinder.de)



\*1 During home return, be careful to avoid interference from peripheral objects because the slider travels until the mechanical end.  
ME: Mechanical end  
SE: Stroke end

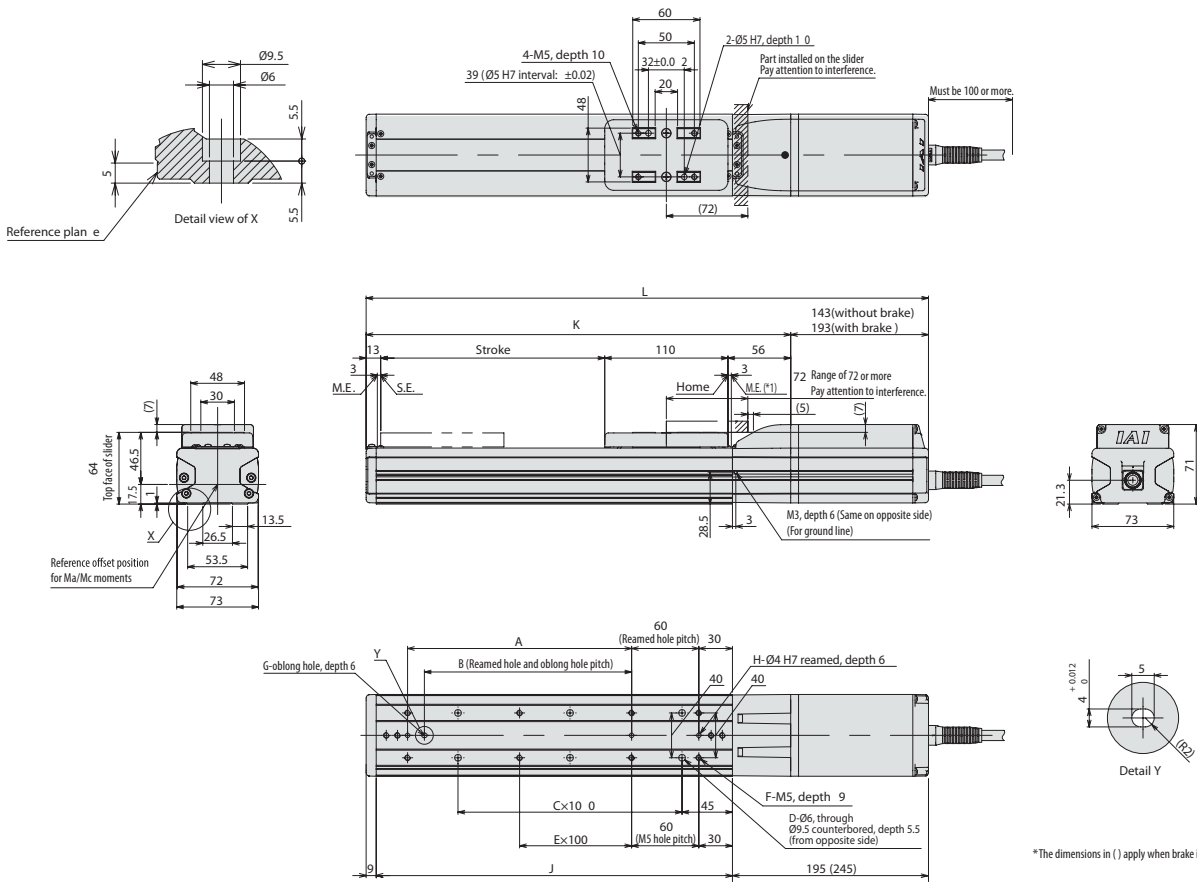

\*The dimensions in ( ) apply when brake is equipped.

■ Dimensions and Mass by Stroke

Stroke	50	100	150	200	250	300	350	400	450	500	550	600	650	700	750	800	
L	Without brake	372	422	472	522	572	622	672	722	772	822	872	922	972	1022	1072	1122
	With brake	422	472	522	572	622	672	722	772	822	872	922	972	1022	1072	1122	1172
A	0	100	100	200	200	300	300	400	400	500	500	600	600	700	700	800	
B	0	85	85	185	185	285	285	385	385	485	485	585	585	685	685	785	
C	1	1	2	2	3	3	4	4	5	5	6	6	7	7	8	8	
D	4	4	6	6	8	8	10	10	12	12	14	14	16	16	18	18	
E	0	0	0	1	1	2	2	3	3	4	4	5	5	6	6	7	
F	4	6	6	8	8	10	10	12	12	14	14	16	16	18	18	20	
G	0	1	1	1	1	1	1	1	1	1	1	1	1	1	1	1	
H	2	3	3	3	3	3	3	3	3	3	3	3	3	3	3	3	
J	168	218	268	318	368	418	468	518	568	618	668	718	768	818	868	918	
K	229	279	329	379	429	479	529	579	629	679	729	779	829	879	929	979	
Mass (kg)	Without brake	3.0	3.2	3.5	3.7	3.9	4.1	4.4	4.6	4.8	5.0	5.3	5.5	5.7	5.9	6.1	6.4
	With brake	3.5	3.7	4.0	4.2	4.4	4.6	4.9	5.1	5.3	5.5	5.8	6.0	6.2	6.4	6.6	6.9

Applicable Controller

RCP5 series actuators can be operated with the controller indicated below. Select the type according to your intended application.

Name	External view	Model number	Features	Maximum number of positioning points	Input power	Power supply capacity	Reference page
Positioner type		PCON-CA-56PWAI-NP-□□□□ PCON-CA-56PWAI-PN-□□□□	Equipped with a high-output driver Positioner type based on PIO control	512 points	DC24V	Refer to P. 46	Refer to P. 39
Pulse-train type		PCON-CA-56PWAI-PLN-□□□□ PCON-CA-56PWAI-PLP-□□□□	Equipped with a high-output driver Pulse-train input type	—			
Field network type		PCON-CA-56PWAI-①□□□□	Equipped with a high-output driver Supporting major field networks	768 points			
Position controller, 8-axis type		MSEP-C-□□-56PWAI-□□□□	Positioner type that accepts connection of up to eight axes.	3 points/256 points			
6-axis type with I/O control function		MSEP-LC-□□-56PWAI-□□□□□□ (*) (*) MSEP-LC coming soon with CE conformity.	Axes can be moved and I/O signal turned ON/OFF using a ladder logic program.	256 points			

\* In the model numbers shown above, ① indicates the field network specification (DV, CC, PR, CN, PRT, EC or EP).

# RCP5-RA4C

RoboCylinder, Rod Type, Motor Unit Coupled, Actuator Width 40mm, 24-V Pulse Motor

Model Specification Items	<b>RCP5</b> — <b>RA4C</b> — <b>WA</b> — <b>35P</b> — <input type="checkbox"/> — <input type="checkbox"/> — <b>P3</b> — <input type="checkbox"/> — <input type="checkbox"/>	Series — Type — Encoder type — Motor type — Lead — Stroke — Applicable controller — Cable length — Options			
	WA : Battery-less absolute specification 35P : Pulse motor, size 35 <input type="checkbox"/>	16 : 16mm 10 : 10mm 5 : 5mm 2.5 : 2.5mm	60 : 60mm 410 : 410mm (every 50mm)	P3 : PCON-CA MSEP-C/LC	N : None P : 1m S : 3m M : 5m X <input type="checkbox"/> : Specified length R <input type="checkbox"/> : Robot cable

Built-in guide mechanism



**POINT**  
Note on selection

(1) The payload in “Actuator Specifications” represents the maximum values, but the payload of a specific model varies depending on the acceleration. For details, refer to “Selection Guideline” (Table of RCP5 Payload by Speed/Acceleration) on pp. 33 to 34.  
(2) Refer to P. 31 for the push-motion operation.

## Correlation Diagrams of Speed and Payload

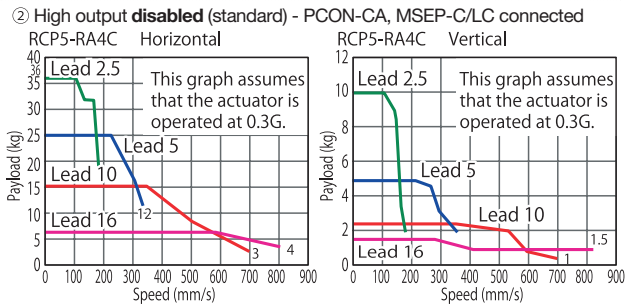
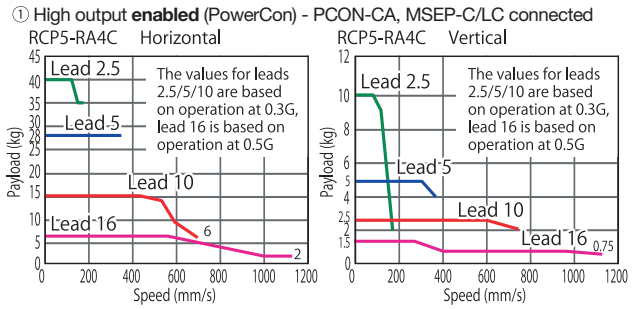

## Actuator Specifications

### Lead and Payload

Model number	Lead (mm)	High output setting	Max. payload		Max. push force (N)	Stroke (mm)
			Horizontal (kg)	Vertical (kg)		
RCP5-RA4C-WA-35P-16-①-P3-②-③	16	Enabled	6	1.5	48	60-410 (every 50mm)
		Disabled				
RCP5-RA4C-WA-35P-10-①-P3-②-③	10	Enabled	15	2.5	77	
		Disabled				
RCP5-RA4C-WA-35P-5-①-P3-②-③	5	Enabled	28	5	155	
		Disabled				
RCP5-RA4C-WA-35P-2.5-①-P3-②-③	2.5	Enabled	40	10	310	
		Disabled	36			

Code explanation ① Stroke ② Cable length ③ Options

### Stroke and Maximum Speed

Lead (mm)	High output setting	Stroke and Maximum Speed (unit: mm/s)	
		60-360 (every 50mm)	410 (mm)
16	Enabled	1120	1080
	Disabled	840	
10	Enabled	700	685
	Disabled		
5	Enabled	350	340
	Disabled		
2.5	Enabled	175	170
	Disabled		

## Cable Length

Type	Cable symbol
Standard type	P(1m)
	S(3m)
	M(5m)
Special length	X06(6m) ~ X10(10m)
	X11(11m) ~ X15(15m)
	X16(16m) ~ X20(20m)
Robot cable	R01(1m) ~ R03(3m)
	R04(4m) ~ R05(5m)
	R06(6m) ~ R10(10m)
	R11(11m) ~ R15(15m)
	R16(16m) ~ R20(20m)

## Option

Name	Option code	See page
Brake	B	→P.10
Flange	FL	→P.59
Tip adapter (flange)	FFA	
Tip adapter (internal thread)	NFA	→P.60
Tip adapter (keyway)	KFA	
Non-motor end specification	NM	→P.10

## Actuator Specifications

Item	Description
Drive system	Ball screw ø8mm, rolled C10
Positioning repeatability	±0.02mm
Lost motion	0.1mm or less
Rod	ø20mm Aluminum
Rod non-rotation precision (*1)	±0 deg
Allowable rod load mass	Refer to P. 18 and P. 35
Rod tip overhang distance	100mm or less
Ambient operating temperature, humidity	0 to 40°C, 85% RH or less (Non-condensing)

(\*1) Accuracy of rod displacement in rotating direction when no load is received.

Offset distance at end of rod (100mm or less)



Dimensional Drawings

CAD drawings can be downloaded from the website. [www.robocylinder.de](http://www.robocylinder.de)



- \*1 During home return, be careful to avoid interference from peripheral objects because the slider travels until the mechanical end.
  - \*2 The orientation of the width across flats varies depending on the product.
  - \*3 If the actuator is installed using the front housing and flange, make sure the actuator will not receive any external force.
- (For details, refer to "Notes on Installing Rod Actuators" on P. 31.)  
 ME: Mechanical end  
 SE: Stroke end

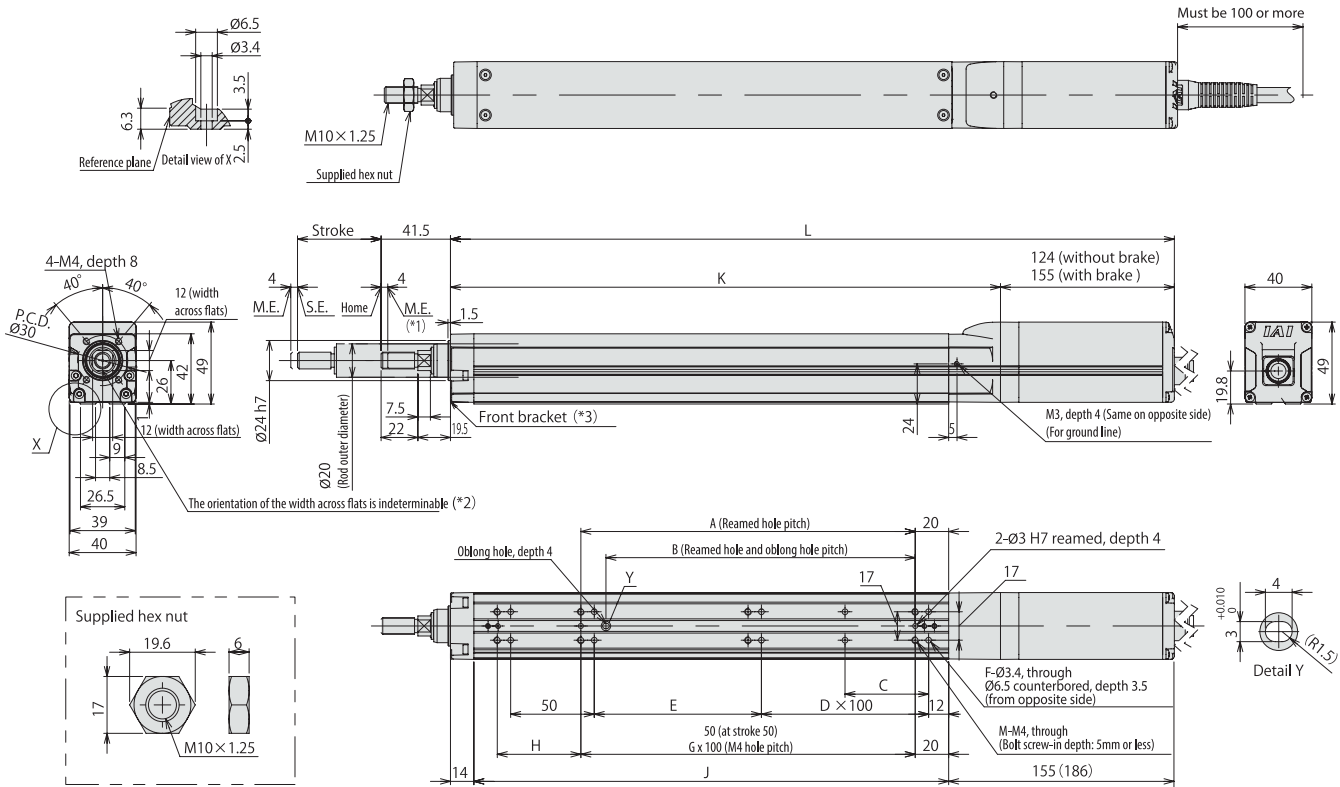

■ Rod Deflection of RCP5-RA4C (Reference Values)

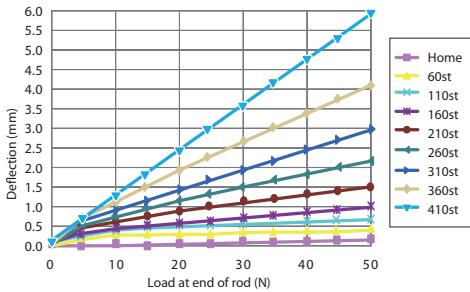

■ Dimensions and Mass by Stroke

\*The dimensions in ( ) apply when brake is equipped.

Stroke	60	110	160	210	260	310	360	410	
L	Without brake	303	353	403	453	503	553	603	653
	With brake	334	384	434	484	534	584	634	684
A	50	100	100	200	200	300	300	400	
B	35	85	85	185	185	285	285	385	
C	25	50	50	50	50	50	50	50	
D	0	0	1	1	2	2	3	3	
E	50	100	50	100	50	100	50	100	
F	8	8	10	10	12	12	14	14	
G	-	1	1	2	2	3	3	4	
H	50	50	100	50	100	50	100	50	
J	134	184	234	284	334	384	434	484	
K	179	229	279	329	379	429	479	529	
M	6	6	6	8	8	10	10	12	
Allowable static load at end of rod (N)	55.8	44.6	37.1	31.7	27.6	24.3	21.7	19.5	
Allowable dynamic load at end of rod (N)	Load offset 0mm	25.4	19.5	15.5	12.8	10.8	9.2	7.9	6.9
	Load offset 100mm	16.5	14.5	12.4	10.7	9.2	8.0	7.0	6.2
Allowable static torque at end of rod (Nm)	5.6	4.5	3.8	3.2	2.8	2.5	2.3	2.1	
Allowable dynamic torque at end of rod (Nm)	1.7	1.5	1.2	1.1	0.9	0.8	0.7	0.6	
Mass (kg)	Without brake	1.1	1.2	1.3	1.4	1.6	1.7	1.8	1.9
	With brake	1.3	1.4	1.5	1.6	1.8	1.9	2.0	2.1

Applicable Controller

RCP5 series actuators can be operated with the controller indicated below. Select the type according to your intended application.

Name	External view	Model number	Features	Maximum number of positioning points	Input power	Power supply capacity	Reference page
Positioner type		PCON-CA-35PWAI-NP-□-□-□ PCON-CA-35PWAI-PN-□-□-□	Equipped with a high-output driver Positioner type based on PIO control	512 points	DC24V	Refer to P. 46	Refer to P. 39
Pulse-train type		PCON-CA-35PWAI-PLN-□-□-□ PCON-CA-35PWAI-PLP-□-□-□	Equipped with a high-output driver Pulse-train input type	—			
Field network type		PCON-CA-35PWAI-□-□-□	Equipped with a high-output driver Supporting major field networks	768 points			
Position controller, 8-axis type		MSEP-C-□-35PWAI-□-□-□	Positioner type that accepts connection of up to eight axes.	3 points/256 points	Refer to P. 55	Refer to P. 47	
6-axis type with I/O control function		MSEP-LC-□-35PWAI-□-□-□ (*) (*) MSEP-LC coming soon with CE conformity.	Axes can be moved and I/O signal turned ON/OFF using a ladder logic program.	256 points			

\* In the model numbers shown above, □ indicates the field network specification (DV, CC, PR, CN, PRT, EC or EP).

# RCP5-RA6C

RoboCylinder, Rod Type, Motor Unit Coupled, Actuator Width 58mm, 24-V Pulse Motor

Model Specification Items	<b>RCP5</b> — <b>RA6C</b> — <b>WA</b> — <b>42P</b> — <input type="checkbox"/> — <input type="checkbox"/> — <b>P3</b> — <input type="checkbox"/> — <input type="checkbox"/>	Series — Type — Encoder type — Motor type — Lead — Stroke — Applicable controller — Cable length — Options
	WA : Battery-less absolute specification 42P : Pulse motor, size 42□ 20 : 20mm 12 : 12mm 6 : 6mm 3 : 3mm 65 : 65mm 415 : 415mm (every 50mm) P3 : PCON-CA MSEP-C/LC N : None P : 1m S : 3m M : 5m X□ : Specified length R□ : Robot cable	Refer to the options table below.

Built-in guide mechanism

RoHS



**POINT**  
Note on selection

(1) The payload in "Actuator Specifications" represents the maximum values, but the payload of a specific model varies depending on the acceleration. For details, refer to "Selection Guideline" (Table of RCP5 Payload by Speed/Acceleration) on pp. 33 to 34.  
(2) Refer to P. 31 for the push-motion operation.

## Correlation Diagrams of Speed and Payload

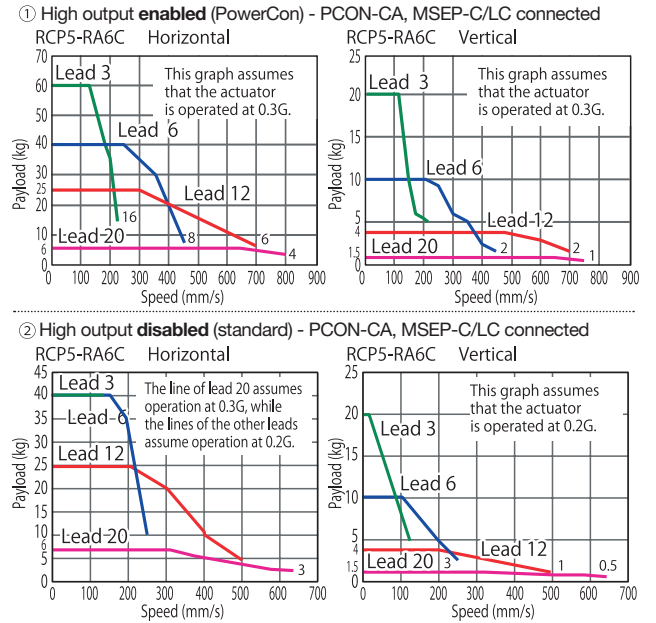

## Actuator Specifications

### Lead and Payload

Model number	Lead (mm)	High output setting	Max. payload		Max. push force (N)	Stroke (mm)
			Horizontal (kg)	Vertical (kg)		
RCP5-RA6C-WA-42P-20-①-P3-②-③	20	Enabled	6	1.5	56	65-415 (every 50mm)
		Disabled				
RCP5-RA6C-WA-42P-12-①-P3-②-③	12	Enabled	25	4	93	
		Disabled				
RCP5-RA6C-WA-42P-6-①-P3-②-③	6	Enabled	40	10	185	
		Disabled				
RCP5-RA6C-WA-42P-3-①-P3-②-③	3	Enabled	60	20	370	
		Disabled				

Code explanation ① Stroke ② Cable length ③ Options

### Stroke and Maximum Speed

(unit: mm/s)

Lead (mm)	High output setting	65~365 (every 50mm)		415 (mm)
		Stroke		Max. speed
20	Enabled	800		
	Disabled	640		
12	Enabled	700		
	Disabled	500		
6	Enabled	450		
	Disabled	250		
3	Enabled	225	220	
	Disabled	125		

### Cable Length

Type	Cable symbol
Standard type	P(1m)
	S(3m)
	M(5m)
Special length	X06(6m) ~ X10(10m)
	X11(11m) ~ X15(15m)
	X16(16m) ~ X20(20m)
	R01(1m) ~ R03(3m)
Robot cable	R04(4m) ~ R05(5m)
	R06(6m) ~ R10(10m)
	R11(11m) ~ R15(15m)
	R16(16m) ~ R20(20m)

### Option

Name	Option code	See page
Brake	B	→P.10
Flange	FL	→P.59
Tip adapter (flange)	FFA	
Tip adapter (internal thread)	NFA	→P.60
Tip adapter (keyway)	KFA	
Non-motor end specification	NM	→P.10

### Actuator Specifications

Item	Description
Drive system	Ball screwφ10mm, rolled C10
Positioning repeatability (*1)	±0.02mm [±0.03mm]
Lost motion	0.1mm or less
Rod	φ25mm Aluminum
Rod non-rotation precision (*2)	±0 deg
Allowable rod load mass	Refer to P. 20 and P. 35
Rod tip overhang distance	100mm or less
Ambient operating temperature, humidity	0 to 40°C, 85% RH or less (Non-condensing)

(\*1) The value at lead 20 is shown in [ ]. (\*2) Accuracy of rod displacement in rotating direction when no load is received.

Offset distance at end of rod (100mm or less)



Dimensional Drawings

CAD drawings can be downloaded from the website: [www.robocylinder.de](http://www.robocylinder.de)



- \*1 During home return, be careful to avoid interference from peripheral objects because the slider travels until the mechanical end.
  - \*2 The orientation of width across flats varies depending on the product.
  - \*3 If the actuator is installed using the front housing and flange, make sure the actuator will not receive any external force.  
(For details, refer to "Notes on Installing Rod Actuators" on P. 31.)
- ME: Mechanical end  
SE: Stroke end

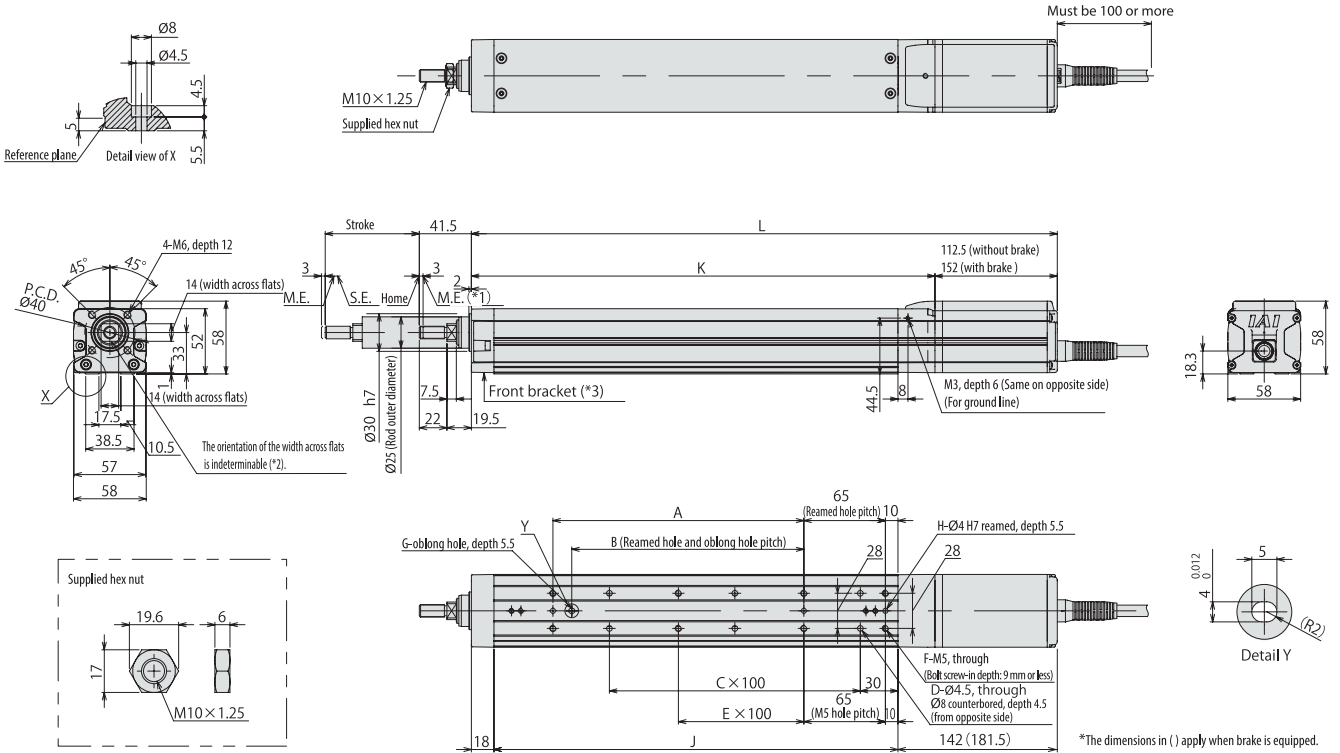

■ Rod Deflection of RCP5-RA6C (Reference Values)

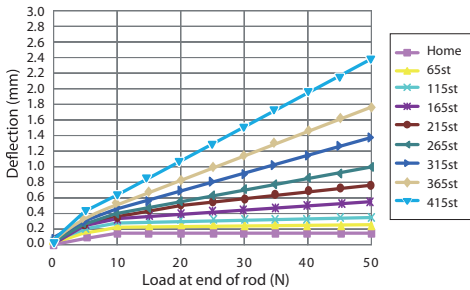

■ Dimensions and Mass by Stroke

Stroke		65	115	165	215	265	315	365	415
L	Without brake	332	382	432	482	532	582	632	682
	With brake	371.5	421.5	471.5	521.5	571.5	621.5	671.5	721.5
A		0	100	100	200	200	300	300	400
B		0	85	85	185	185	285	285	385
C		1	1	2	2	3	3	4	4
D		4	4	6	6	8	8	10	10
E		0	0	0	1	1	2	2	3
F		4	6	6	8	8	10	10	12
G		0	1	1	1	1	1	1	1
H		2	3	3	3	3	3	3	3
J		172	222	272	322	372	422	472	522
K		219.5	269.5	319.5	369.5	419.5	469.5	519.5	569.5
Allowable static load at end of rod (N)		113.8	92.6	78.0	67.3	59.0	52.5	47.2	42.8
Allowable dynamic load at end of rod (N)		45.7	36.3	29.8	25.1	21.6	18.8	16.6	14.7
Allowable static torque at end of rod (Nm)		11.5	9.4	7.9	6.8	6.0	5.4	4.9	4.5
Allowable dynamic torque at end of rod (Nm)		3.2	2.8	2.5	2.1	1.9	1.7	1.5	1.3
Mass (kg)	Without brake	1.8	2.0	2.2	2.4	2.6	2.9	3.1	3.3
	With brake	2.0	2.2	2.4	2.6	2.8	3.1	3.3	3.5

Applicable Controller

RCP5 series actuators can be operated with the controller indicated below. Select the type according to your intended application.

Name	External view	Model number	Features	Maximum number of positioning points	Input power	Power supply capacity	Reference page
Positioner type		PCON-CA-42PWAI-NP-□-□-□ PCON-CA-42PWAI-PN-□-□-□	Equipped with a high-output driver Positioner type based on PIO control	512 points	DC24V	Refer to P. 46	Refer to P. 39
Pulse-train type		PCON-CA-42PWAI-PLN-□-□-□ PCON-CA-42PWAI-PLP-□-□-□	Equipped with a high-output driver Pulse-train input type	—			
Field network type		PCON-CA-42PWAI-□-□-□-□	Equipped with a high-output driver Supporting major field networks	768 points			
Position controller, 8-axis type	MSEP-C-□-42PWAI-□-□-□	Positioner type that accepts connection of up to eight axes.	3 points/256 points				
6-axis type with I/O control function	MSEP-LC-□-42PWAI-□-□-□-□ (*) (*) MSEP-LC coming soon with CE conformity.	Axes can be moved and I/O signal turned ON/OFF using a ladder logic program.	256 points				

\* In the model numbers shown above, □ indicates the field network specification (DV, CC, PR, CN, PRT, EC or EP).

# RCP5-RA7C

RoboCylinder, Rod Type, Motor Unit Coupled, Actuator Width 73mm, 24-V Pulse Motor

Model Specification Items	<b>RCP5</b> - Series	<b>RA7C</b> - Type	<b>WA</b> - Encoder type	<b>56P</b> - Motor type	Lead	Stroke	<b>P3</b> - Applicable controller	Cable length	Options
			WA : Battery-less absolute specification	56P : Pulse motor, size 56	24 : 24mm 16 : 16mm 8 : 8mm 4 : 4mm	70 : 70mm 520 : 520mm (every 50mm)	P3 : PCON-CA MSEP-C/LC	N : None P : 1m S : 3m M : 5m X : Specified length R : Robot cable	Refer to the options table below.

Built-in guide mechanism

RoHS



**POINT**  
Note on selection

(1) The payload in "Actuator Specifications" represents the maximum values, but the payload of a specific model varies depending on the acceleration. For details, refer to "Selection Guideline" (Table of RCP5 Payload by Speed/Acceleration) on pp. 33 to 34.  
(2) Refer to P. 31 for the push-motion operation.

## Correlation Diagrams of Speed and Payload

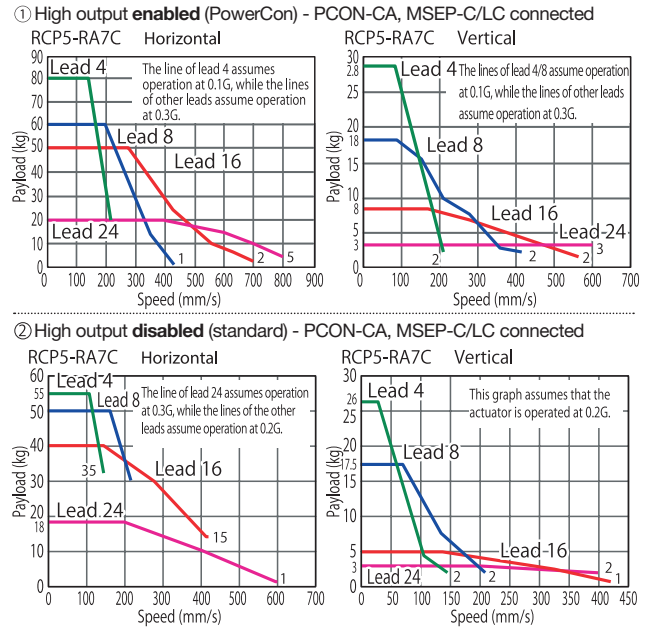

## Actuator Specifications

### Lead and Payload

Model number	Lead (mm)	High output setting	Max. payload		Max. push force (N)	Stroke (mm)
			Horizontal (kg)	Vertical (kg)		
RCP5-RA7C-WA-56P-24-①-P3-②-③	24	Enabled	20	3	182	70-520 (every 50mm)
		Disabled	18	3		
RCP5-RA7C-WA-56P-16-①-P3-②-③	16	Enabled	50	8	273	
		Disabled	40	5		
RCP5-RA7C-WA-56P-8-①-P3-②-③	8	Enabled	60	18	547	
		Disabled	50	17.5		
RCP5-RA7C-WA-56P-4-①-P3-②-③	4	Enabled	80	28	1094	
		Disabled	55	26		

Code explanation ① Stroke ② Cable length ③ Options

### Stroke and Maximum Speed

The values in <> apply when the actuator is used vertically. (unit: mm/s)

Lead (mm)	High output setting	70-520 (every 50mm)
24	Enabled	800 <600>
	Disabled	600 <400>
16	Enabled	700 <560>
	Disabled	420
8	Enabled	420
	Disabled	210
4	Enabled	210
	Disabled	140

## Cable Length

Type	Cable symbol
Standard type	P(1m)
	S(3m)
	M(5m)
Special length	X06(6m) ~ X10(10m)
	X11(11m) ~ X15(15m)
	X16(16m) ~ X20(20m)
Robot cable	R01(1m) ~ R03(3m)
	R04(4m) ~ R05(5m)
	R06(6m) ~ R10(10m)
	R11(11m) ~ R15(15m)
	R16(16m) ~ R20(20m)

## Option

Name	Option code	See page
Brake	B	→P.10
Flange	FL	→P.59
Tip adapter (flange)	FFA	
Tip adapter (internal thread)	NFA	→P.60
Tip adapter (keyway)	KFA	
Non-motor end specification	NM	→P.10

## Actuator Specifications

Item	Description
Drive system	Ball screw ø12mm, rolled C10
Positioning repeatability (*1)	±0.02mm [±0.03mm]
Lost motion	0.1mm or less
Rod	ø30mm Aluminum
Rod non-rotation precision (*2)	±0 deg
Allowable rod load mass	Refer to P. 22 and P. 35
Rod tip overhang distance	100mm or less
Ambient operating temperature, humidity	0 to 40°C, 85% RH or less (Non-condensing)

(\*1) The value at lead 24 is shown in [1]. (\*2) Accuracy of rod displacement in rotating direction when no load is received.

Offset distance at end of rod (100mm or less)

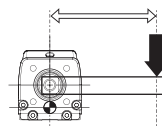

Load at end of rod

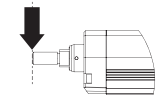

Dimensional Drawings

CAD drawings can be downloaded from the website. [www.robocylinder.de](http://www.robocylinder.de)



- \*1 During home return, be careful to avoid interference from peripheral objects because the slider travels until the mechanical end.
  - \*2 The orientation of the width across flats varies depending on the product.
  - \*3 If the actuator is installed using the front housing and flange, make sure the actuator will not receive any external force.  
(For details, refer to "Notes on Installing Rod Actuators" on P. 31.)
- ME: Mechanical end  
SE: Stroke end

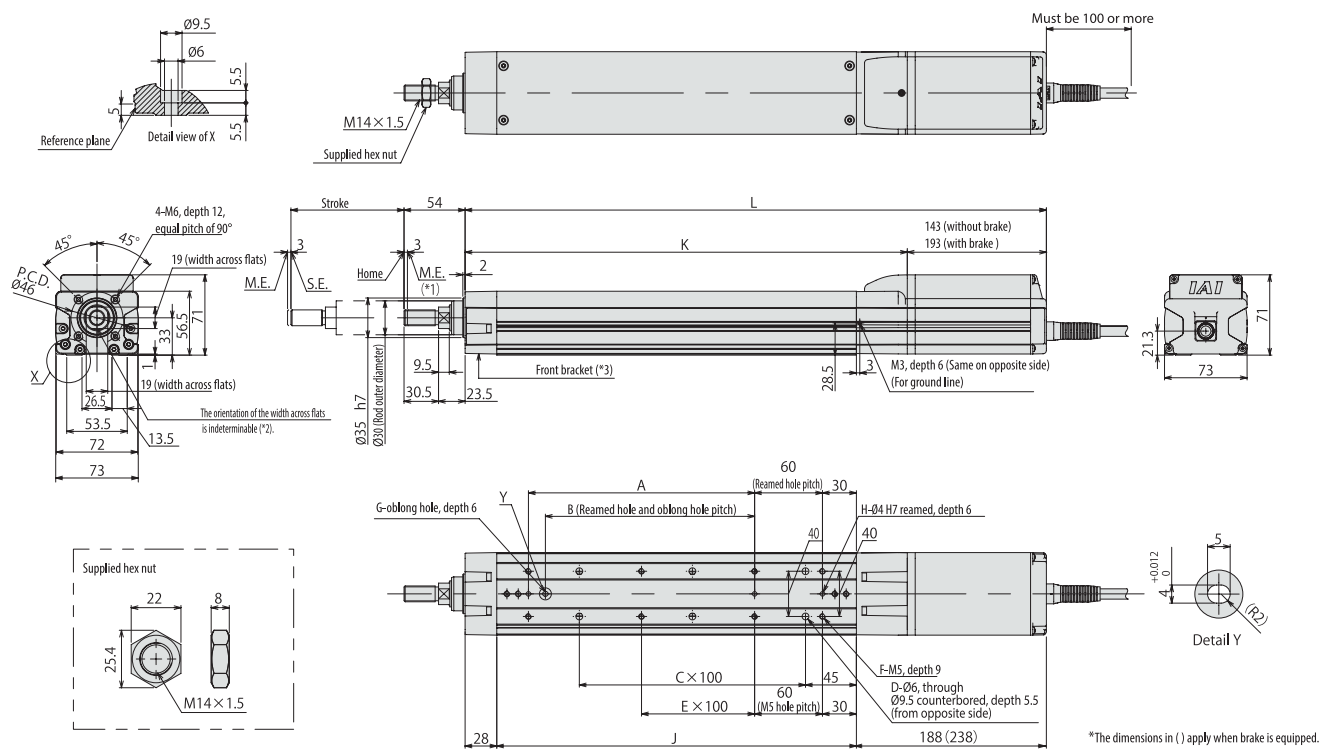

■ Rod Deflection of RCP5-RA7C (Reference Values)

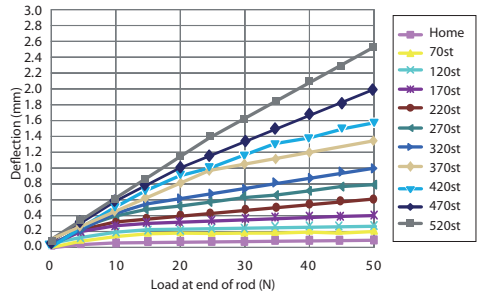

■ Dimensions and Mass by Stroke

L	Stroke	70	120	170	220	270	320	370	420	470	520
	Without brake	384	434	484	534	584	634	684	734	784	834
With brake	434	484	534	584	634	684	734	784	834	884	
A	0	100	100	200	200	300	300	400	400	500	
B	0	85	85	185	185	285	285	385	385	485	
C	1	1	2	2	3	3	4	4	5	5	
D	4	4	6	6	8	8	10	10	12	12	
E	0	0	0	1	1	2	2	3	3	4	
F	4	6	6	8	8	10	10	12	12	14	
G	0	1	1	1	1	1	1	1	1	1	
H	2	3	3	3	3	3	3	3	3	3	
J	168	218	268	318	368	418	468	518	568	618	
K	241	291	341	391	441	491	541	591	641	691	
Allowable static load at end of rod (N)	Without brake	119.2	97.7	82.8	71.6	63.0	56.2	50.6	46.0	42.2	38.8
	With brake	44.3	35.7	29.6	25.2	21.7	19.0	16.8	15.0	13.6	12.2
Allowable dynamic load at end of rod (N)	Load offset 0mm	33.9	29.7	25.7	22.4	19.7	17.4	15.5	14.0	12.8	11.5
	Load offset 100mm	12.1	10.0	8.5	7.4	6.5	5.9	5.3	4.9	4.5	4.1
Allowable static torque at end of rod (Nm)	Without brake	3.4	3.0	2.6	2.2	2.0	1.7	1.6	1.4	1.3	1.2
	With brake	3.3	3.6	3.9	4.2	4.5	4.8	5.1	5.4	5.6	5.9
Mass (kg)	Without brake	3.3	3.6	3.9	4.2	4.5	4.8	5.1	5.4	5.6	5.9
	With brake	3.8	4.1	4.4	4.7	5.0	5.3	5.6	5.9	6.1	6.4

Applicable Controller

RCP5 series actuators can be operated with the controller indicated below. Select the type according to your intended application.

Name	External view	Model number	Features	Maximum number of positioning points	Input power	Power supply capacity	Reference page
Positioner type		PCON-CA-56PWAI-NP-□□□□□□	Equipped with a high-output driver Positioner type based on PIO control	512 points	DC24V	Refer to P. 46	Refer to P. 39
Pulse-train type		PCON-CA-56PWAI-PLN-□□□□□□ PCON-CA-56PWAI-PLP-□□□□□□	Equipped with a high-output driver Pulse-train input type	—			
Field network type		PCON-CA-56PWAI-□□-□□□□□□	Equipped with a high-output driver Supporting major field networks	768 points			
Position controller, 8-axis type		MSEP-C-□□-56PWAI-□□□□□□	Positioner type that accepts connection of up to eight axes.	3 points/256 points	Refer to P. 55	Refer to P. 47	
6-axis type with I/O control function		MSEP-LC-□□-56PWAI-□□□□□□ (*) (*) MSEP-LC coming soon with CE conformity.	Axes can be moved and I/O signal turned ON/OFF using a ladder logic program.	256 points			

\* In the model numbers shown above, □ indicates the field network specification (DV, CC, PR, CN, PRT, EC or EP).

# RCP5-RA8C

RoboCylinder, High-thrust Rod Type, Motor Unit Coupled, Actuator Width 88mm, 24-V Pulse Motor

Model Specification Items	<b>RCP5</b>	<b>RA8C</b>	<b>WA</b>	<b>60P</b>	<input type="checkbox"/>	<input type="checkbox"/>	<b>P4</b>	<input type="checkbox"/>	<input type="checkbox"/>
	Series	Type	Encoder type	Motor type	Lead	Stroke	Applicable controller	Cable length	Options
			WA : Battery-less absolute specification	60P : Pulse motor, size 60 <input type="checkbox"/>	20 : 20mm 10 : 10mm 5 : 5mm	50 : 50mm 700 : 700mm (every 50mm)	P4 : PCON-CFA	N : None P : 1m S : 3m M : 5m X <input type="checkbox"/> : Specified length R <input type="checkbox"/> : Robot cable	Refer to the options table below.

Built-in guide mechanism

RoHS



**POINT**  
Note on selection

- (1) The payload assumes operation at an acceleration of 0.1G for lead 5 and operation at an acceleration of 0.2G for lead 10 and lead 20. The above values are the upper limits of acceleration/deceleration.
- (2) Exercise caution that the RA8C requires a dedicated controller (high-thrust PCON-CFA).

## Correlation Diagrams of Speed and Payload

RCP5-RA8C Horizontal PCON-CFA connected

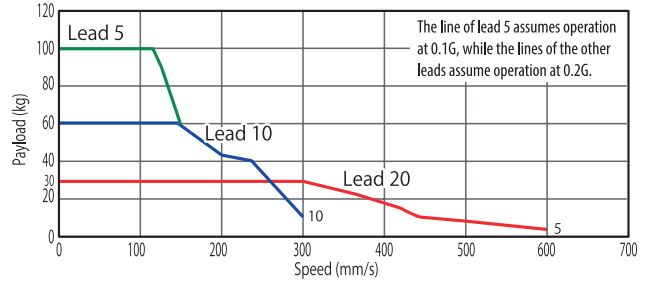

RCP5-RA8C Vertical PCON-CFA connected

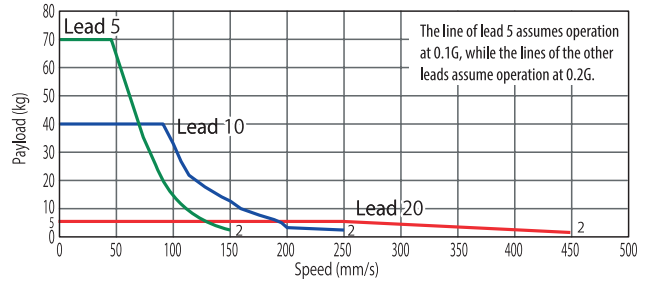

## Actuator Specifications

### Lead and Payload

Model number	Lead (mm)	Connected controller	Maximum payload		Maximum push force (N)	Stroke (mm)
			Horizontal (kg)	Vertical (kg)		
RCP5-RA8C-WA-60P-20-①-P4-②-③	20	PCON-CFA	30	5	500	50~700 (every 50mm)
RCP5-RA8C-WA-60P-10-①-P4-②-③	10	PCON-CFA	60	40	1000	
RCP5-RA8C-WA-60P-5-①-P4-②-③	5	PCON-CFA	100	70	2000	

Code explanation ① Stroke ② Cable length ③ Options

### Stroke and Maximum Speed

The values in <> apply when the actuator is used vertically. (unit: mm/s)

Lead (mm)	50 (mm)	100 (mm)	150 (mm)	200 (mm)	250-350 (mm)	400 (mm)	450 (mm)	500 (mm)	550 (mm)	600 (mm)	650 (mm)	700 (mm)
20	280	405	505 <450>	585 <450>	600 <450>	520 <450>	440	360	320	280	240	220
10	280 <250>		300 <250>			260 <250>	220	180	160	140	120	110
5			150			130	110	90	80	70	60	55

## Cable Length

Type	Cable symbol
Standard type	P (1m)
	S (3m)
	M (5m)
Special length	X06(6m) ~ X10(10m)
	X11(11m) ~ X15(15m)
	X16(16m) ~ X20(20m)
Robot cable	R01(1m) ~ R03(3m)
	R04(4m) ~ R05(5m)
	R06(6m) ~ R10(10m)
	R11(11m) ~ R15(15m)
	R16(16m) ~ R20(20m)

## Option

Name	Option code	See page
Brake	B	→P.10
Optional cable exit direction (top)	CJT	
Optional cable exit direction (right)	CJR	
Optional cable exit direction (left)	CJL	
Optional cable exit direction (bottom)	CJB	
Flange bracket	FL	
Non-motor end specification	NM	

## Actuator Specifications

Item	Description
Drive system	Ball screw $\phi$ 16mm, rolled C10
Positioning repeatability	$\pm$ 0.02mm
Lost motion	0.1mm or less
Rod	$\phi$ 40mm Aluminum
Rod non-rotation precision (*1)	$\pm$ 0 deg
Allowable rod load mass	Refer to P. 24 and P. 35
Rod tip overhang distance	100mm or less
Ambient operating temperature, humidity	0 to 40°C, 85% RH or less (Non-condensing)

(\*1) Accuracy of rod displacement in rotating direction when no load is received.

Offset distance at end of rod (100mm or less)





Dimensional Drawings

CAD drawings can be downloaded from the website. [www.robocylinder.de](http://www.robocylinder.de)



- \*1 During home return, be careful to avoid interference from peripheral objects because the slider travels until the mechanical end.
- \*2 The orientation of the width across flats varies depending on the product.
- \*3 If the actuator is installed using the front housing and flange, make sure the actuator will not receive any external force.  
(For details, refer to "Notes on Installing Rod Actuators" on P. 31.)  
ME: Mechanical end  
SE: Stroke end

■ Dimensions with Flange (Optional)

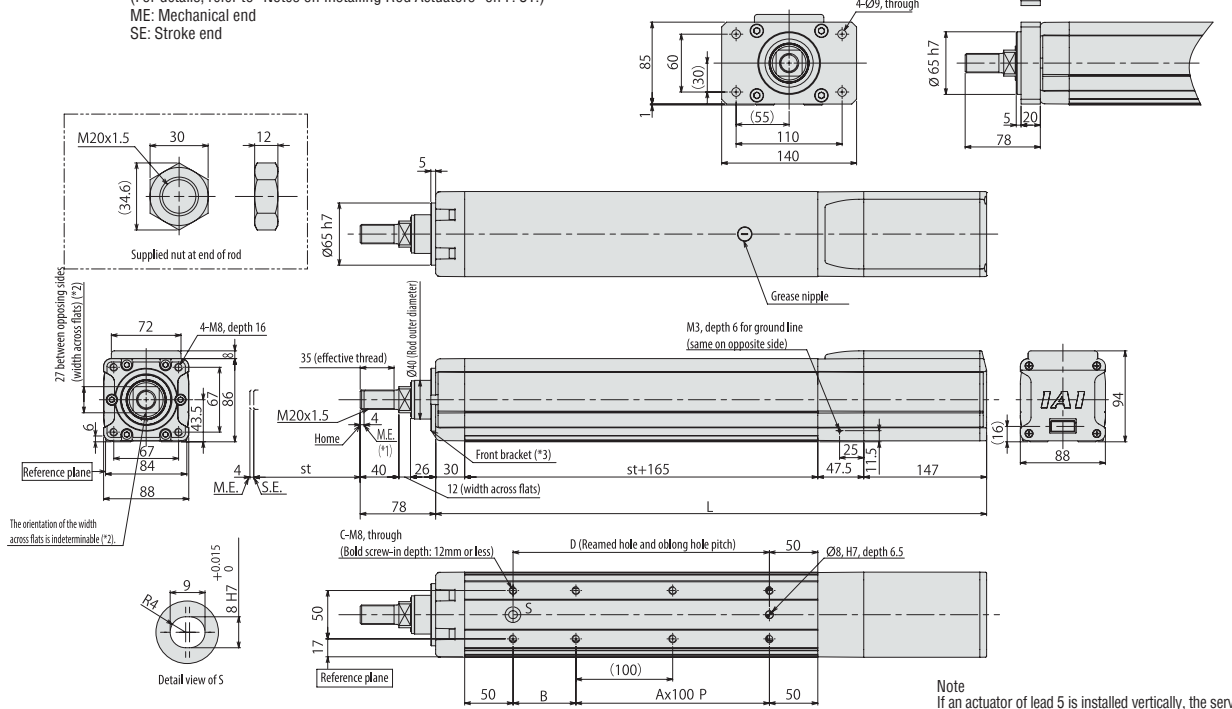

■ Dimensions with Brake (Optional) ■ 4 Cable Exit Directions (Optional)

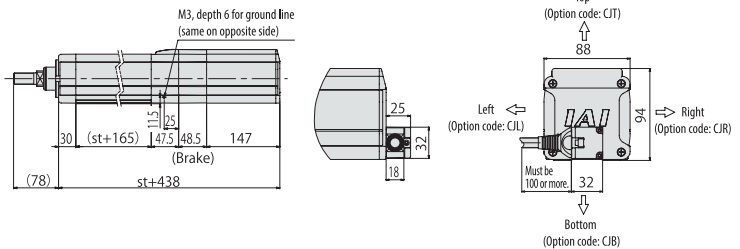

Note  
If an actuator of lead 5 is installed vertically, the service life of the actuator varies significantly depending on the payload.  
Pay attention to the diagram of payload and service life shown below. (If the actuator is installed horizontally, its service life is not affected by the payload.)

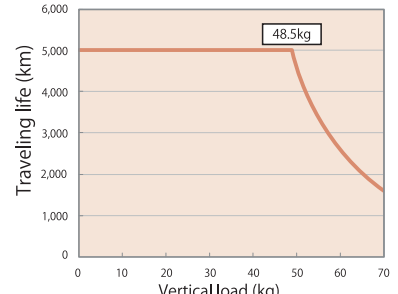

■ Rod Deflection of RCP5-RA8C

(The graph below shows the measurements of how much a horizontally installed rod would deflect when a load is applied to the end of the rod. The measured deflection include the deflection due to the weight of the rod.)

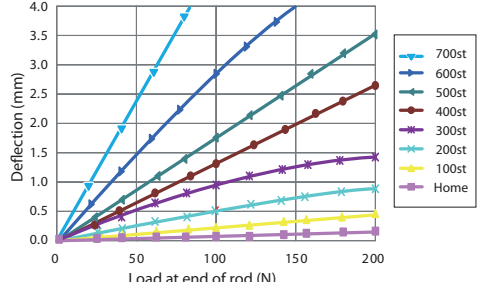

■ Dimensions and Mass by Stroke

Stroke	50	100	150	200	250	300	350	400	450	500	550	600	650	700	
L	Without brake	439.5	489.5	539.5	589.5	639.5	689.5	739.5	789.5	839.5	889.5	939.5	989.5	1039.5	1089.5
	With brake	488	538	588	638	688	738	788	838	888	938	988	1038	1088	1138
A	0	1	1	2	2	3	3	4	4	5	5	6	6	7	
B	115	65	115	65	115	65	115	65	115	65	115	65	115	65	
C	4	6	6	8	8	10	10	12	12	14	14	16	16	18	
D	115	165	215	265	315	365	415	465	515	565	615	665	715	765	
Allowable static load at end of rod (N)	180	150.3	128.9	112.7	99.9	89.7	81.3	74.3	68.3	63.1	58.6	54.6	51.1	47.9	
Allowable dynamic load at end of rod (N)	Load offset 0mm	73.6	60.3	51.0	44.1	38.7	34.3	30.7	27.7	25.2	22.5	17.7	14.2	11.6	9.5
	Load offset 100mm	57.0	48.6	42.5	37.8	33.8	30.5	27.6	25.2	23.1	21.2	17.7	14.2	11.6	9.5
Allowable static torque at end of rod (Nm)	18.1	15.2	13.0	11.4	10.2	9.2	8.4	7.7	7.1	6.6	6.1	5.8	5.4	5.1	
Allowable dynamic torque at end of rod (Nm)	5.7	9.7	8.5	7.5	6.7	6.0	5.5	5.0	4.6	4.2	3.9	3.6	3.3	3.0	
Mass (kg)	Without brake	7.1	7.6	8.0	8.4	8.9	9.3	9.7	10.2	10.6	11.0	11.4	11.9	12.3	12.7
	With brake	8.3	8.7	9.1	9.6	10.0	10.4	10.9	11.3	11.7	12.1	12.6	13.0	13.4	13.9

Applicable Controller

RCP5 series actuators can be operated with the controller indicated below. Select the type according to your intended application.

Name	External view	Model number	Features	Maximum number of positioning points	Input power	Power supply capacity	Reference page
Positioner type		PCON-CFA-60PWAI-NP-□-0-□ PCON-CFA-60PWAI-PN-□-0-□	Positioner type based on PIO control	512 points	DC24V	Refer to P. 46	Refer to P. 39
Pulse-train type		PCON-CFA-60PWAI-PLN-□-0-□ PCON-CFA-60PWAI-PLP-□-0-□	Pulse-train input type	—			
Field network type		PCON-CFA-60PWAI-□-0-0-□	Supporting major field networks	768 points			

\* In the model numbers shown above, □ indicates the field network specification (DV, CC, PR, CN, PRT, EC or EP).

# RCP5-RA10C

RoboCylinder, High-thrust Rod Type, Motor Unit Coupled, Actuator Width 108mm, 24-V Pulse Motor

Model Specification Items	<b>RCP5</b>	<b>RA10C</b>	<b>WA</b>	<b>86P</b>			<b>P4</b>		
	Series	Type	Encoder type	Motor type	Lead	Stroke	Applicable controller	Cable length	Options
			WA : Battery-less absolute specification	86P : Pulse motor, size 86	10 : 10mm 5 : 5mm 2.5 : 2.5mm	50 : 50mm 800 : 800mm (every 50mm)	P4 : PCON-CFA	N : None P : 1m S : 3m M : 5m X <input type="checkbox"/> : Specified length R <input type="checkbox"/> : Robot cable	Refer to the options table below.

Built-in guide mechanism

RoHS

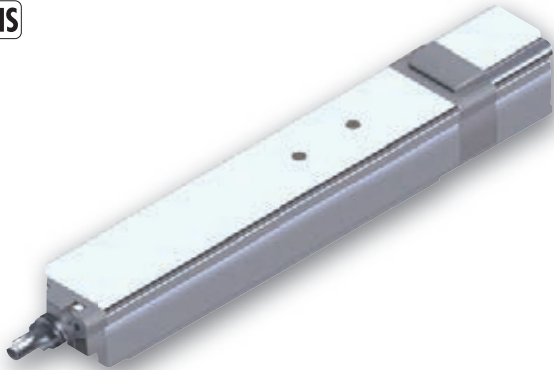

POINT  
Note on selection

- The payload assumes operation at an acceleration of 0.01G for lead 2.5, operation at an acceleration of 0.02G for lead 5 and operation at an acceleration of 0.04G for lead 10. The above values are the upper limits of acceleration/deceleration.
- Exercise caution that the RA10C requires a dedicated controller (high-thrust PCON-CFA).

## Correlation Diagrams of Speed and Payload

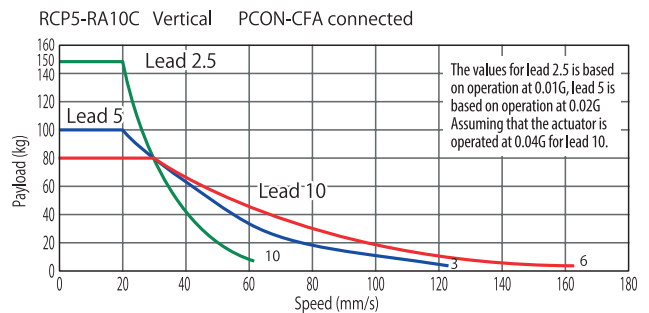
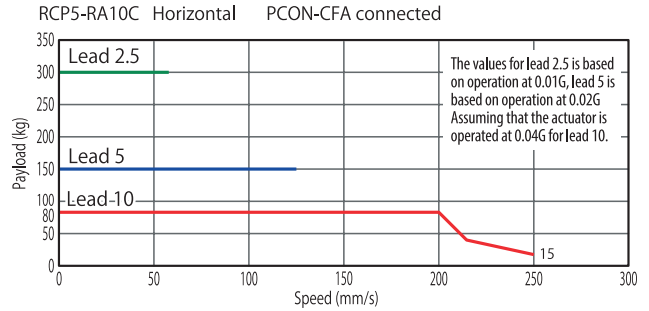

## Actuator Specifications

### Lead and Payload

Model number	Lead (mm)	Connected controller	Maximum payload		Maximum push force (N)	Stroke (mm)
			Horizontal (kg)	Vertical (kg)		
RCP5-RA10C-WA-86P-10-①-P4-②-③	10	PCON-CFA	80	80	1500	50-800 (every 50mm)
RCP5-RA10C-WA-86P-5-①-P4-②-③	5	PCON-CFA	150	100	3000	
RCP5-RA10C-WA-86P-2.5-①-P4-②-③	2.5	PCON-CFA	300	150	6000	

Code explanation ① Stroke ② Cable length ③ Options

### Stroke and Maximum Speed

The values in <> apply when the actuator is used vertically. (unit: mm/s)

Lead (mm)	50 (mm)	100 (mm)	150 (mm)	200-400 (mm) (every 50mm)	450 (mm)	500 (mm)	550 (mm)	600 (mm)	650 (mm)	700 (mm)	750 (mm)	800 (mm)
10	117	167	200	<167>	250	<167>	220	200	180	160	140	120
5	83		125		110	90	80	70	60	55	50	45
2.5			63				55	50	45	40	35	30

## Cable Length

Type	Cable symbol
Standard type	P(1m)
	S(3m)
	M(5m)
Special length	X06(6m) ~ X10(10m)
	X11(11m) ~ X15(15m)
	X16(16m) ~ X20(20m)
Robot cable	R01(1m) ~ R03(3m)
	R04(4m) ~ R05(5m)
	R06(6m) ~ R10(10m)
	R11(11m) ~ R15(15m)
	R16(16m) ~ R20(20m)

## Option

Name	Option code	See page
Brake	B	→P.10
Optional cable exit direction (top)	CJT	
Optional cable exit direction (right)	CJR	
Optional cable exit direction (left)	CJL	
Optional cable exit direction (bottom)	CJB	
Flange bracket	FL	
Non-motor end specification	NM	

## Actuator Specifications

Item	Description
Drive system	Ball screw $\varnothing$ 20mm (lead 2.5/10mm), $\varnothing$ 16mm (lead 5mm), rolled C10
Positioning repeatability	$\pm$ 0.02mm
Lost motion	0.1mm or less
Rod	$\varnothing$ 40mm Aluminum
Rod non-rotation precision (*1)	$\pm$ 0 deg
Allowable rod load mass	Refer to P. 26 and P. 35
Rod tip overhang distance	100mm or less
Ambient operating temperature, humidity	0 to 40°C, 85% RH or less (Non-condensing)

(\*1) Accuracy of rod displacement in rotating direction when no load is received.

Offset distance at end of rod (100mm or less)

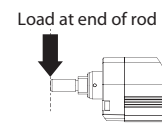
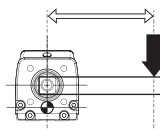

Dimensional Drawings

CAD drawings can be downloaded from the website. [www.robocylinder.de](http://www.robocylinder.de)



- \*1 During home return, be careful to avoid interference from peripheral objects because the slider travels until the mechanical end.
  - \*2 The orientation of the width across flats varies depending on the product.
  - \*3 If the actuator is installed with the front housing and flange, make sure the actuator will not receive any external force. (For details, refer to "Notes on Installing Rod Actuators" on P. 31.)
- ME: Mechanical end  
SE: Stroke end

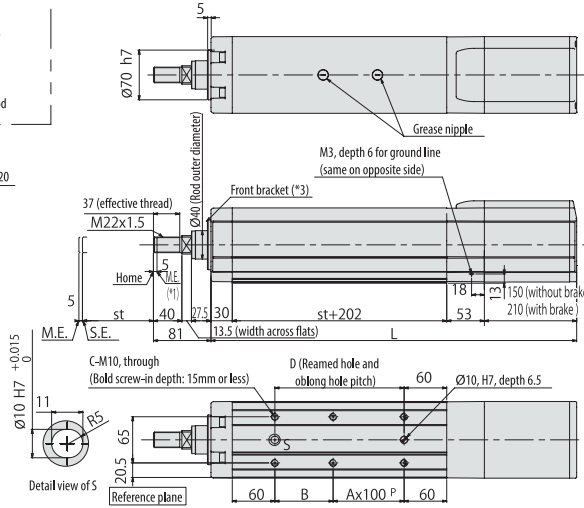
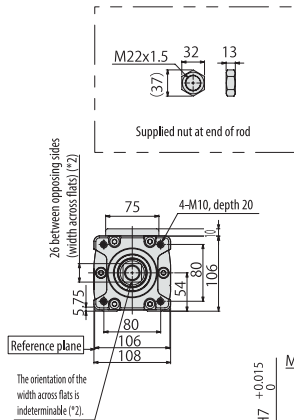

Dimensions with Flange (Optional)

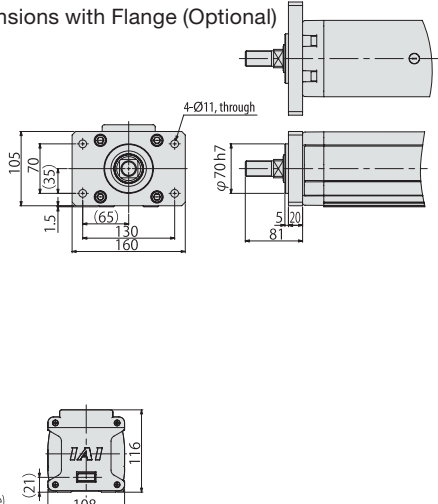

4 Cable Exit Directions (Optional)

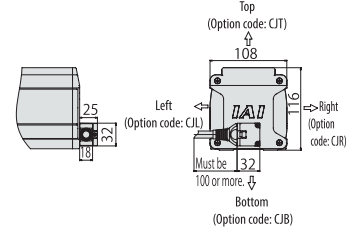

Rod Deflection of RCP5-RA10C

(The graph below shows the measurements of how much a horizontally installed rod would deflect when a load is applied to the end of the rod. The measured deflection include the deflection due to the weight of the rod.)

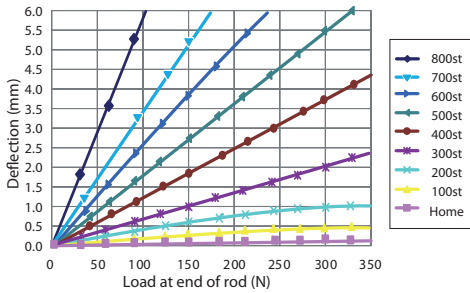

Dimensions and Mass by Stroke

Stroke	Dimensions and Mass by Stroke																
	50	100	150	200	250	300	350	400	450	500	550	600	650	700	750	800	
L	Without brake	485	535	585	635	685	735	785	835	885	935	985	1035	1085	1135	1185	1235
	With brake	545	595	645	695	745	795	845	895	945	995	1045	1095	1145	1195	1245	1295
A	0	1	1	2	2	3	3	4	4	5	5	6	6	7	7	8	
B	132	82	132	82	132	82	132	82	132	82	132	82	132	82	132	82	
C	4	6	6	8	8	10	10	12	12	14	14	16	16	18	18	20	
D	132	182	232	282	332	382	432	482	532	582	632	682	732	782	832	882	
Allowable static load at end of rod (N)	Without brake	316.9	268.4	232.6	205.1	183.4	165.7	151.0	138.6	128.1	119.0	111.0	103.9	97.7	92.1	87.0	82.5
	With brake	545	495	445	395	345	295	245	195	145	95	45	-5	-105	-155	-205	-255
Allowable dynamic load at end of rod (N)	Load offset 0mm	119.1	99.1	84.7	73.8	65.3	58.5	52.8	48.2	44.2	40.5	37.2	34.2	31.5	29.0	26.8	24.8
	Load offset 100mm	100.7	85.9	74.9	66.3	59.3	53.6	48.8	44.5	40.7	37.4	34.4	31.7	29.2	26.9	24.8	22.8
Allowable static torque at end of rod (Nm)	Without brake	31.8	27.0	23.4	20.7	18.5	16.8	15.3	14.1	13.1	12.2	11.4	10.7	10.1	9.6	9.1	8.6
	With brake	545	495	445	395	345	295	245	195	145	95	45	-5	-105	-155	-205	-255
Mass (kg)	Without brake	11.5	12.2	12.9	13.6	14.3	15	15.7	16.4	17.1	17.8	18.5	19.2	19.9	20.6	21.3	22
	With brake	13.1	13.8	14.5	15.2	15.9	16.6	17.3	18	18.7	19.4	20.1	20.8	21.5	22.2	22.9	23.6

Correlation Diagrams of Vertical Load and Traveling Life

Since the RCP5-RA10C has a greater maximum thrust than other types, its service life varies significantly depending on the payload and push force applied when the actuator is installed vertically. When selecting an appropriate type from the correlation diagram of speed and payload or correlation diagram of push force and current-limiting value, check its traveling life on the correlation diagram of payload and service life as well as on the correlation diagram of push force and service life.

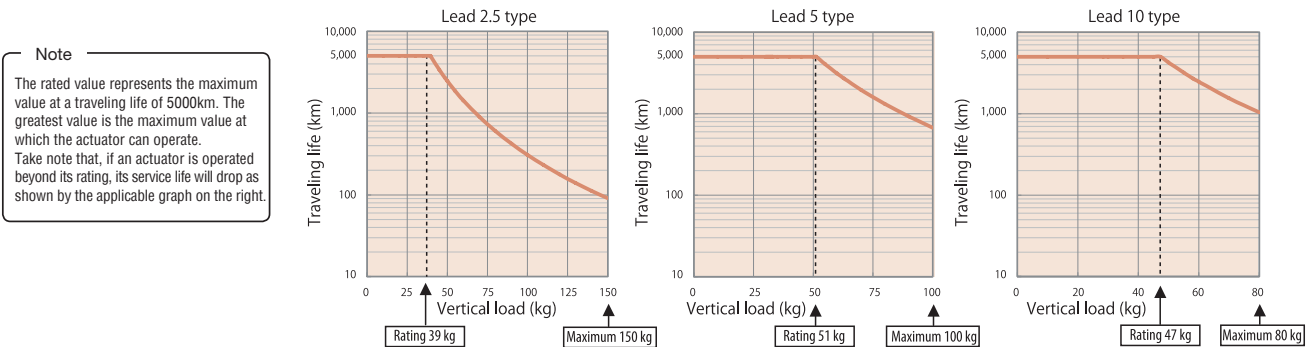

Applicable Controller

RCP5 series actuators can be operated with the controller indicated below. Select the type according to your intended application.

Name	External view	Model number	Features	Maximum number of positioning points	Input power	Power supply capacity	Reference page
Positioner type		PCON-CFA-86PWAI-NP-□-0-□ PCON-CFA-86PWAI-PN-□-0-□	Positioner type based on PIO control	512 points	DC24V	Refer to P. 46	Refer to P. 39
Pulse-train type		PCON-CFA-86PWAI-PLN-□-0-□ PCON-CFA-86PWAI-PLP-□-0-□	Pulse-train input type	—			
Field network type		PCON-CFA-86PWAI-□-0-0-□	Supporting major field networks	768 points			

\* In the model numbers shown above, □ indicates the field network specification (DV, CC, PR, CN, PRT, EC or EP).

# RCP5-RA8R

RoboCylinder, High-thrust Rod Type, Side Mounted Motor Type, Actuator Width 88mm, 24-V Pulse Motor

Model Specification Items	<b>RCP5</b>	<b>RA8R</b>	<b>WA</b>	<b>60P</b>	<input type="checkbox"/>	<input type="checkbox"/>	<b>P4</b>	<input type="checkbox"/>	<input type="checkbox"/>
	Series	Type	Encoder type	Motor type	Lead	Stroke	Applicable controller	Cable length	Options
			WA : Battery-less absolute specification	60P : Pulse motor, size 60 <input type="checkbox"/>	20 : 20mm 10 : 10mm 5 : 5mm	50 : 50mm 700 : 700mm (every 50mm)	P4 : PCON-CFA	N : None P : 1m S : 3m M : 5m X <input type="checkbox"/> : Specified length R <input type="checkbox"/> : Robot cable	Refer to the options table below.

Built-in guide mechanism

RoHS

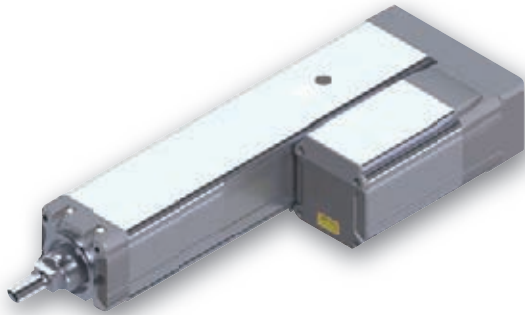

- POINT**  
Note on selection
- (1) The payload assumes operation at an acceleration of 0.1G for lead 5 and operation at an acceleration of 0.2G for lead 10 and lead 20. The above values are the upper limits of acceleration/deceleration.
  - (2) Exercise caution that the RA8R requires a dedicated controller (high-thrust PCON-CFA).

### Correlation Diagrams of Speed and Payload

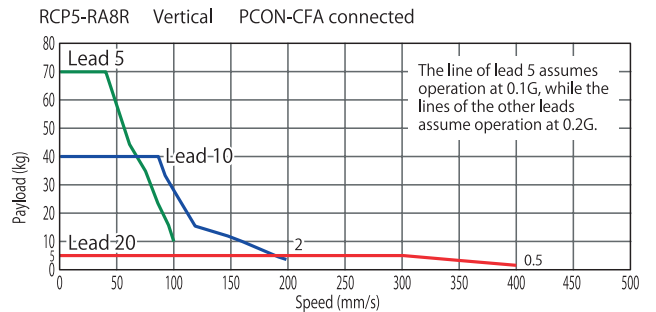
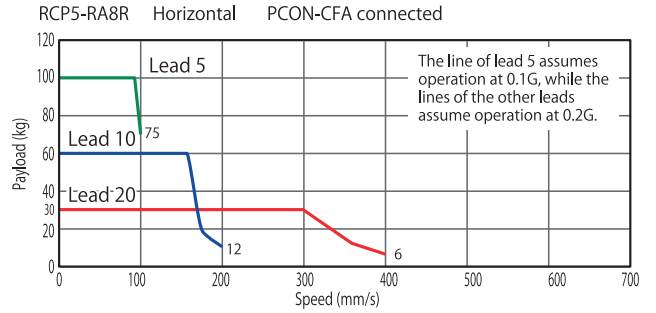

### Actuator Specifications

#### Lead and Payload

Model number	Lead (mm)	Connected controller	Maximum payload		Maximum push force (N)	Stroke (mm)
			Horizontal (kg)	Vertical (kg)		
RCP5-RA8R-WA-60P-20-①-P4-②-③	20	PCON-CFA	30	5	500	50~700 (every 50mm)
RCP5-RA8R-WA-60P-10-①-P4-②-③	10	PCON-CFA	60	40	1000	
RCP5-RA8R-WA-60P-5-①-P4-②-③	5	PCON-CFA	100	70	2000	

Code explanation ① Stroke ② Cable length ③ Options

#### Stroke and Maximum Speed

(unit: mm/s)

Lead (mm)	50 (mm)	100~450 (mm)	500 (mm)	550 (mm)	600 (mm)	650 (mm)	700 (mm)
20	280	400	360	320	280	240	220
10	200	180	160	140	120	110	
5	100	90	80	70	60	55	

### Cable Length

Type	Cable symbol
Standard type	P(1m)
	S(3m)
	M(5m)
Special length	X06(6m) ~ X10(10m)
	X11(11m) ~ X15(15m)
	X16(16m) ~ X20(20m)
Robot cable	R01(1m) ~ R03(3m)
	R04(4m) ~ R05(5m)
	R06(6m) ~ R10(10m)
	R11(11m) ~ R15(15m)
	R16(16m) ~ R20(20m)

### Option

Name	Option code	See page
Brake	B	→P.10
Optional cable exit direction (top)	CJT	
Optional cable exit direction (outside)	CJO	
Optional cable exit direction (bottom)	CJB	
Motor side-mounted to the left (standard)	ML	
Motor side-mounted to the right	MR	
Flange bracket	FL	
Non-motor end specification	NM	

### Actuator Specifications

Item	Description
Drive system	Ball screw Ø16mm, rolled C10
Positioning repeatability	±0.02mm
Lost motion	0.1mm or less
Rod	Ø40mm Aluminum
Rod non-rotation precision (*1)	±0 deg
Allowable rod load mass	Refer to P. 28 and P. 35
Rod tip overhang distance	100mm or less
Ambient operating temperature, humidity	0 to 40°C, 85% RH or less (Non-condensing)

(\*1) Accuracy of rod displacement in rotating direction when no load is received.

Offset distance at end of rod (100mm or less)

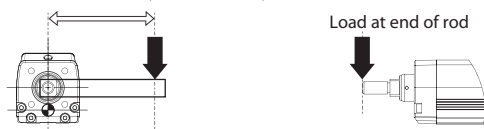

Dimensional Drawings

CAD drawings can be downloaded from the website. [www.robocylinder.de](http://www.robocylinder.de)



- \*1 During home return be careful to avoid interference from peripheral objects because the slider travels until the mechanical end.
- \*2 The orientation of the width across flats varies depending on the product.
- \*3 If the actuator is installed using the front housing and flange, make sure the actuator will not receive any external force.  
(For details, refer to "Notes on Installing Rod Actuators" on P. 31.)  
ME: Mechanical end  
SE: Stroke end

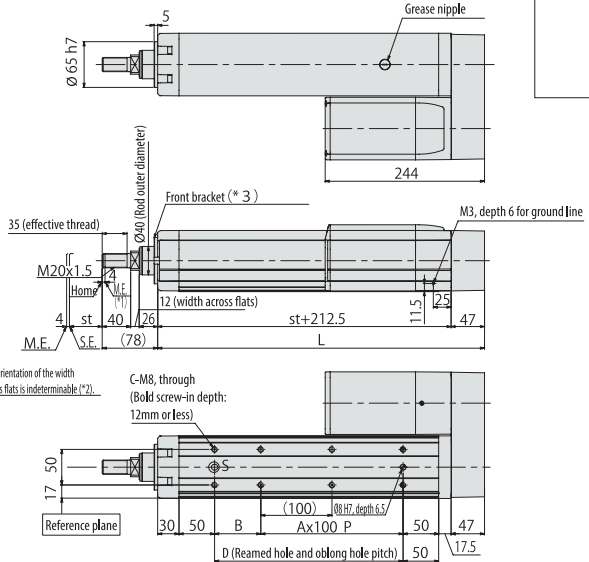
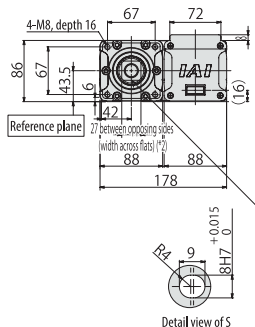
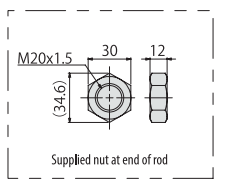
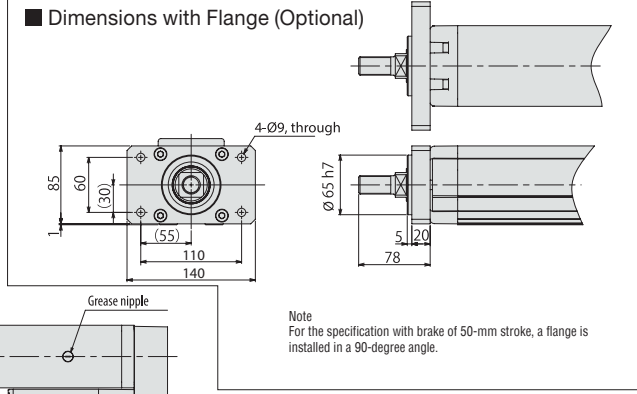

**Dimensions with Brake (Optional)**

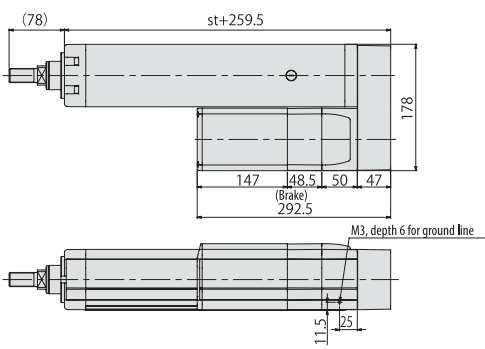

**3 Cable Exit Directions (Optional)**

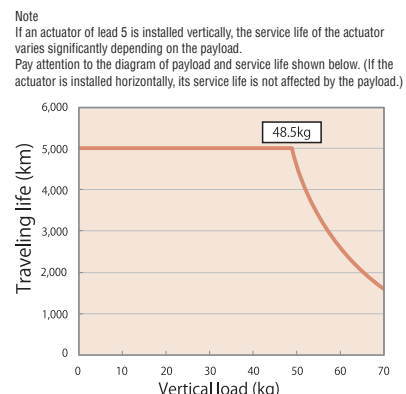
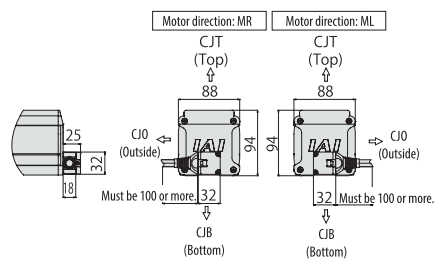

**Rod Deflection of RCP5-RA8R**

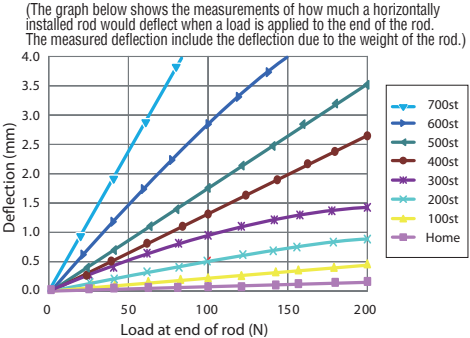

**Dimensions and Mass by Stroke**

Stroke	50	100	150	200	250	300	350	400	450	500	550	600	650	700
L	309.5	359.5	409.5	459.5	509.5	559.5	609.5	659.5	709.5	759.5	809.5	859.5	909.5	959.5
A	0	1	1	2	2	3	3	4	4	5	5	6	6	7
B	115	65	115	65	115	65	115	65	115	65	115	65	115	65
C	4	6	6	8	8	10	10	12	12	14	14	16	16	18
D	115	165	215	265	315	365	415	465	515	565	615	665	715	765
Allowable static load at end of rod (N)	180	150.3	128.9	112.7	99.9	89.7	81.3	74.3	68.3	63.1	58.6	54.6	51.1	47.9
Allowable dynamic load at end of rod (N)	73.6	60.3	51.0	44.1	38.7	34.3	30.7	27.7	25.2	22.5	17.7	14.2	11.6	9.5
Load offset 0mm	57.0	48.6	42.5	37.8	33.8	30.5	27.6	25.2	23.1	21.2	17.7	14.2	11.6	9.5
Load offset 100mm	57.0	48.6	42.5	37.8	33.8	30.5	27.6	25.2	23.1	21.2	17.7	14.2	11.6	9.5
Allowable static torque at end of rod (Nm)	18.1	15.2	13.0	11.4	10.2	9.2	8.4	7.7	7.1	6.6	6.1	5.8	5.4	5.1
Allowable dynamic torque at end of rod (Nm)	5.7	9.7	8.5	7.5	6.7	6.0	5.5	5.0	4.6	4.2	3.9	3.6	3.3	3.0
Mass (kg)	Without brake	8.6	9.0	9.4	9.8	10.3	10.7	11.1	11.6	12.0	12.4	12.9	13.3	13.7
	With brake	9.6	10.0	10.4	10.9	11.3	11.7	12.2	12.6	13.0	13.4	13.9	14.3	14.7

Applicable Controller

RCP5 series actuators can be operated with the controller indicated below. Select the type according to your intended application.

Name	External view	Model number	Features	Maximum number of positioning points	Input power	Power supply capacity	Reference page
Positioner type		PCON-CFA-60PWAI-NP-□-□-□ PCON-CFA-60PWAI-PN-□-□-□	Positioner type based on PIO control	512 points	DC24V	Refer to P. 46	Refer to P. 39
Pulse-train type		PCON-CFA-60PWAI-PLN-□-□-□ PCON-CFA-60PWAI-PLP-□-□-□	Pulse-train input type	—			
Field network type		PCON-CFA-60PWAI-□-0-0-□	Supporting major field networks	768 points			

\* In the model numbers shown above, □ indicates the field network specification (DV, CC, PR, CN, PRT, EC or EP).

# RCP5-RA10R

RoboCylinder, High-thrust Rod Type, Side Mounted Motor Type, Actuator Width 108mm, 24-V Pulse Motor

Model Specification Items	<b>RCP5</b>	<b>RA10R</b>	<b>WA</b>	<b>86P</b>			<b>P4</b>		
	Series	Type	Encoder type	Motor type	Lead	Stroke	Applicable controller	Cable length	Options
			WA : Battery-less absolute specification	86P : Pulse motor, size 86□	10 : 10mm 5 : 5mm 2.5 : 2.5mm	50 : 50mm 800 : 800mm (every 50mm)	P4 : PCON-CFA	N : None P : 1m S : 3m M : 5m X□□ : Specified length R□□ : Robot cable	Refer to the options table below.

Built-in guide mechanism

RoHS

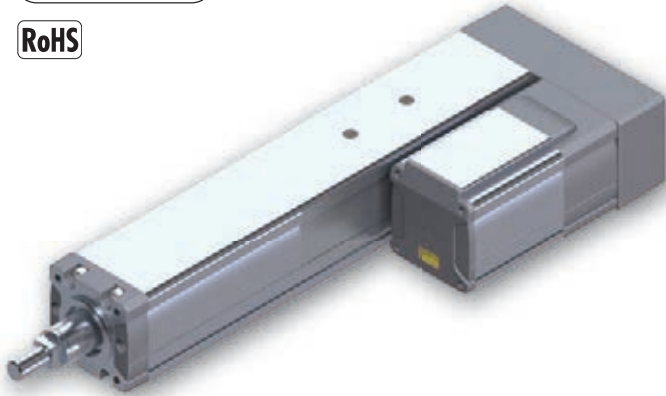

POINT  
Note on selection

- (1) The payload assumes operation at an acceleration of 0.01G for lead 2.5, operation at an acceleration of 0.02G for lead 5 and operation at an acceleration of 0.04G for lead 10. The above values are the upper limits of acceleration/deceleration.
- (2) Exercise caution that the RA10R requires a dedicated controller (high-thrust PCON-CFA).

## Correlation Diagrams of Speed and Payload

RCP5-RA10R Horizontal PCON-CFA connected

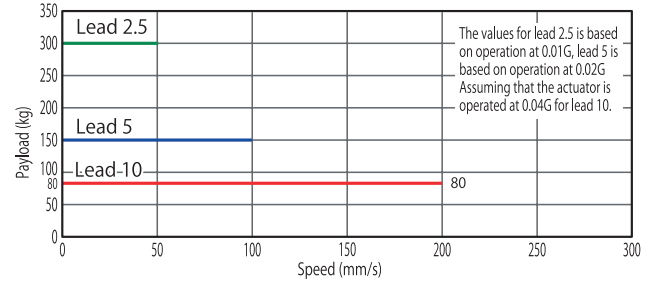

RCP5-RA10R Vertical PCON-CFA connected

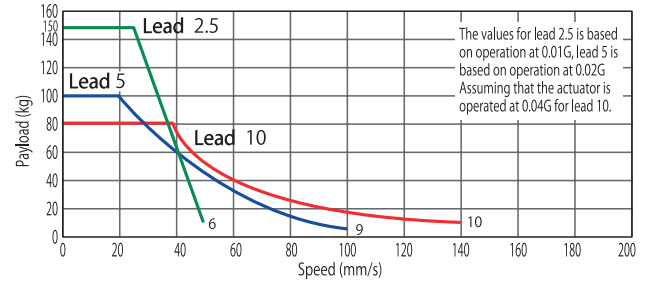

## Actuator Specifications

### Lead and Payload

Model number	Lead (mm)	Connected controller	Maximum payload		Maximum push force (N)	Stroke (mm)
			Horizontal (kg)	Vertical (kg)		
RCP5-RA10R-WA-86P-10-①-P4-②-③	10	PCON-CFA	80	80	1500	50-800 (every 50mm)
RCP5-RA10R-WA-86P-5-①-P4-②-③	5	PCON-CFA	150	100	3000	
RCP5-RA10R-WA-86P-2.5-①-P4-②-③	2.5	PCON-CFA	300	150	6000	

Code explanation ① Stroke ② Cable length ③ Options

### Stroke and Maximum Speed

The values in <> apply when the actuator is used vertically. (unit: mm/s)

Lead (mm)	50 (mm)	100 (mm)	150 (mm)	200-400 (mm) (every 50mm)	450 (mm)	500 (mm)	550 (mm)	600 (mm)	650 (mm)	700 (mm)	750 (mm)	800 (mm)
10	117	167 <140>		200 <140>					180 <140>	160 <140>	140	120
5	83		100		90	80	70	60	55	50	45	
2.5				50					45	40	35	30

## Cable Length

Type	Cable symbol
Standard type	P(1m)
	S(3m)
	M(5m)
Special length	X06(6m) ~ X10(10m)
	X11(11m) ~ X15(15m)
	X16(16m) ~ X20(20m)
Robot cable	R01(1m) ~ R03(3m)
	R04(4m) ~ R05(5m)
	R06(6m) ~ R10(10m)
	R11(11m) ~ R15(15m)
	R16(16m) ~ R20(20m)

## Option

Name	Option code	See page
Brake	B	
Optional cable exit direction (top)	CJT	→P:10
Optional cable exit direction (outside)	CJO	
Optional cable exit direction (bottom)	CJB	
Motor side-mounted to the left (standard)	ML	
Motor side-mounted to the right	MR	
Flange bracket	FL	
Non-motor end specification	NM	

## Actuator Specifications

Item	Description
Drive system	Ball screw Ø20mm (lead 2.5/10mm), Ø16mm (lead 5mm), rolled C10
Positioning repeatability	±0.02mm
Lost motion	0.1mm or less
Rod	Ø40mm Aluminum
Rod non-rotation precision (*1)	±0 deg
Allowable rod load mass	Refer to P. 30 and P. 35
Rod tip overhang distance	100mm or less
Ambient operating temperature, humidity	0 to 40°C, 85% RH or less (Non-condensing)

(\*1) Accuracy of rod displacement in rotating direction when no load is received.

Offset distance at end of rod (100mm or less)

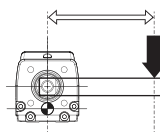

Load at end of rod

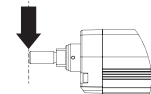

Dimensional Drawings

CAD drawings can be downloaded from the website. [www.robocylinder.de](http://www.robocylinder.de)



- \*1 During home return, be careful to avoid interference from peripheral objects because the slider travels until the mechanical end.
  - \*2 The orientation of the width across flats varies depending on the product.
  - \*3 If the actuator is installed using the front housing and flange, make sure the actuator will not receive any external force. (For details, refer to "Notes on Installing Rod Actuators" on P. 31.)
- ME: Mechanical end  
SE: Stroke end

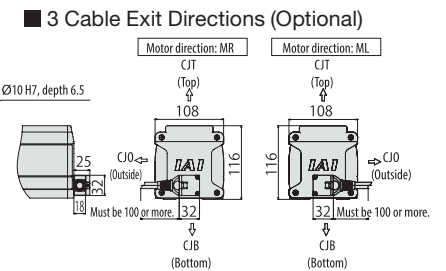
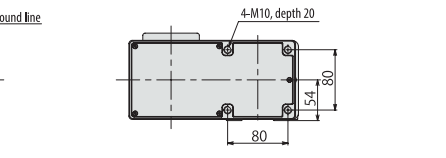
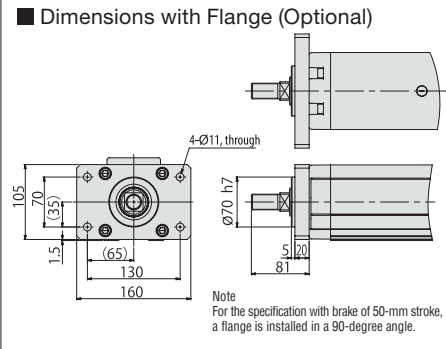
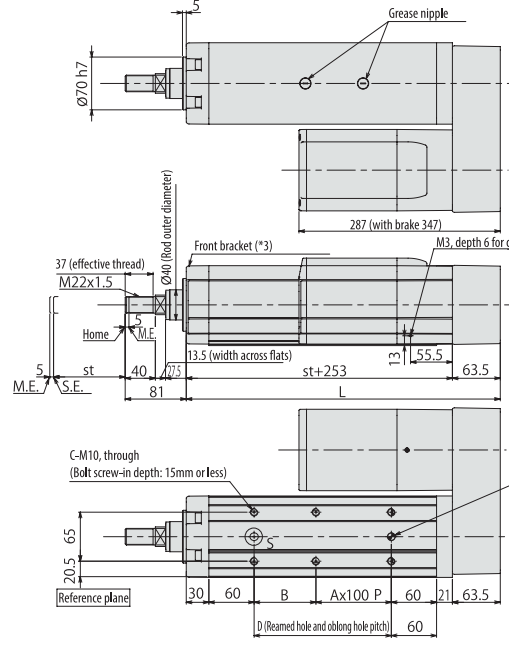
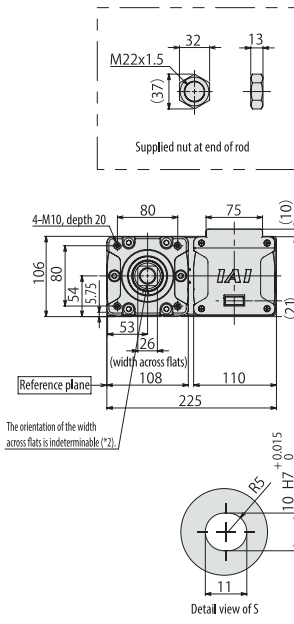

■ Rod Deflection of RCP5-RA10R

(The graph below shows the measurements of how much a horizontally installed rod would deflect when a load is applied to the end of the rod. The measured deflection include the deflection due to the weight of the rod.)

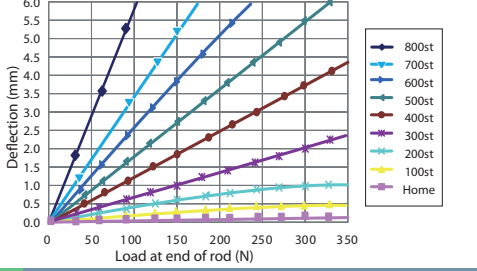

■ Dimensions and Mass by Stroke

Stroke	50	100	150	200	250	300	350	400	450	500	550	600	650	700	750	800
L	366.5	416.5	466.5	516.5	566.5	616.5	666.5	716.5	766.5	816.5	866.5	916.5	966.5	1016.5	1066.5	1116.5
A	0	1	1	2	2	3	3	4	4	5	5	6	6	7	7	8
B	132	82	132	82	132	82	132	82	132	82	132	82	132	82	132	82
C	4	6	6	8	8	10	10	12	12	14	14	16	16	18	18	20
D	132	182	232	282	332	382	432	482	532	582	632	682	732	782	832	882
Allowable static load at end of rod (N)	Load offset 0mm	316.9	268.4	232.6	205.1	183.4	165.7	151.0	138.6	128.1	119.0	111.0	103.9	97.7	92.1	87.0
	Load offset 100mm	100.7	85.9	74.9	66.3	59.3	53.6	48.8	38.7	29.2	22.5	17.7	14.2	11.6	9.5	8.0
Allowable static torque at end of rod (Nm)	Load offset 0mm	31.8	27.0	23.4	20.7	18.5	16.8	15.3	14.1	13.1	12.2	11.4	10.7	10.1	9.6	9.1
	Load offset 100mm	10.1	9.7	8.5	7.5	6.7	6.0	5.5	5.0	4.6	4.2	3.9	3.6	3.3	3.0	3.0
Mass (kg)	Without brake	14.6	15.3	16.0	16.7	17.4	18.1	18.8	19.5	20.2	20.9	21.6	22.3	23.0	23.7	24.4
	With brake	16.2	16.9	17.6	18.3	19.0	19.7	20.4	21.1	21.8	22.5	23.2	23.9	24.6	25.3	26.0

Correlation Diagrams of Vertical Load and Traveling Life

● Since the RCP5-RA10R has a greater maximum thrust than other types, its service life varies significantly depending on the payload and push force applied when the actuator is installed vertically. When selecting an appropriate type from the correlation diagram of speed and payload or correlation diagram of push force and current-limiting value, check its traveling life on the correlation diagram of payload and service life as well as on the correlation diagram of push force and service life.

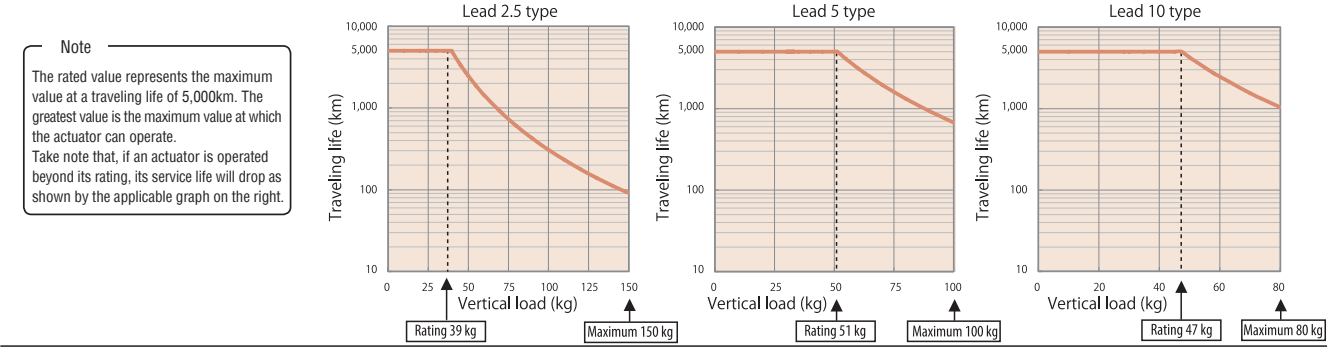

**Applicable Controller**

RCP5 series actuators can be operated with the controller indicated below. Select the type according to your intended application.

Name	External view	Model number	Features	Maximum number of positioning points	Input power	Power supply capacity	Reference page
Positioner type		PCON-CFA-86PWAI-NP-□-0-□	Positioner type based on PIO control	512 points	DC24V	Refer to P. 46	Refer to P. 39
Pulse-train type		PCON-CFA-86PWAI-PLN-□-0-□					
Field network type		PCON-CFA-86PWAI-PLP-□-0-□	Supporting major field networks	768 points			

\* In the model numbers shown above, □ indicates the field network specification (DV, CC, PR, CN, PRT, EC or EP).

## Points to Note/Selection **RCP5** series

### Notes on Installing Rod Actuators

When installing the actuator using the front housing or with a flange (optional), make sure that the actuator will not receive any external forces. (External forces may cause malfunction or damaged parts.) If the actuator will receive external forces or when the actuator is combined with a Cartesian robot, etc., use the mounting holes on the actuator base to secure the actuator.

Even when the actuator does not receive any external forces, provide a support base to support the actuator, as shown in the figure on the right, if the actuator is installed horizontally and secured using a flange or through the bracket mounting holes of the side-mounted motor specification.

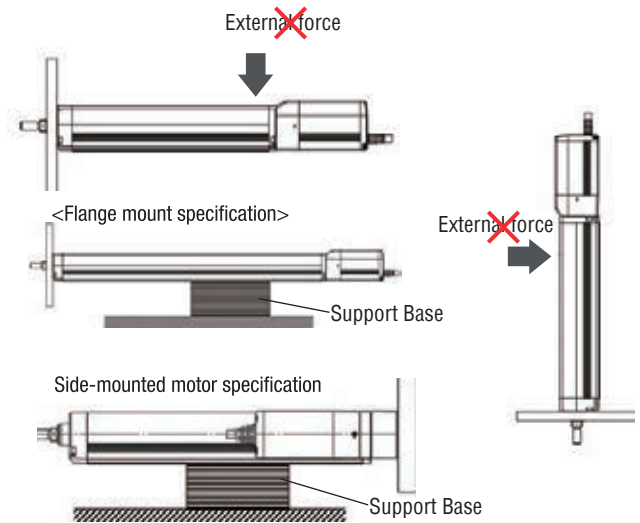

### Selection Guideline (Correlation Diagram of Push Force and Current-limiting Value)

In push-motion operation, the push force can be used by changing the current-limiting value of the controller over a range of 20% to 70%. The maximum push-force varies depending on the model, so check the required push force from the graphs on the following pages and select an appropriate type meeting the purpose of use.

When performing push-motion operation using a slider actuator, limit the push current limit so that the reactive moment generated by the push force will not exceed 80% of the rated moment ( $M_a$ ,  $M_b$ ) specified in the catalog. To help with the moment calculations, the application position of the guide moment is shown in the figure below. Calculate the necessary moment by considering the offset of the push force application position. Note that if an excessive force exceeding the rated moment is applied, the guide may be damaged and the life may become shorter. Accordingly, include a sufficient safety factor when deciding on the push force.

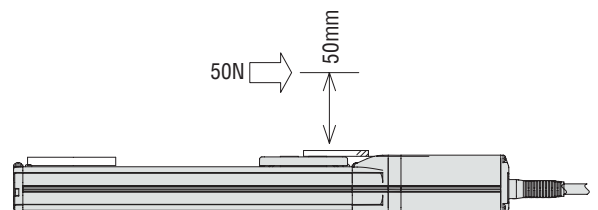
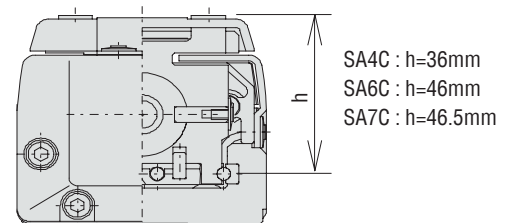

**Calculation example:**

If push-motion operation is performed with an RCP5-SA7C by applying 50 N at the position shown to the right, the moment received by the guide, or

$$M_a \text{ is calculated as } (46.5 + 50) \times 50 = 4825 \text{ (Nmm)} \\ = 4.825 \text{ (Nm)}$$

Since the rated  $M_a$  moment of the SA7C is 10 (Nm),  $10 \times 0.8 = 8 > 4.825$ , suggesting that this selection is acceptable.

If an  $M_b$  moment generates due to push-motion operation, calculate the moment from the overhang and confirm, in the same way, that the calculated moment is within 80% of the rated moment.



**Correlation Diagrams of Push Force and Current-limiting value** The graphs below are only a reference, and the graphs may vary slightly from the actual values.

**SA4C/RA4C type**

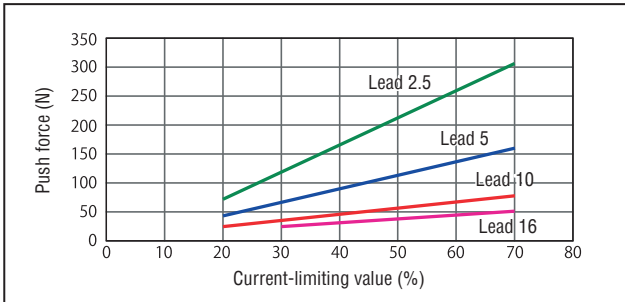

**SA6C/RA6C type**

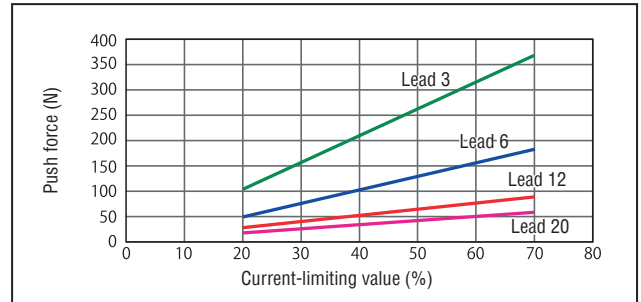

**SA7C type**

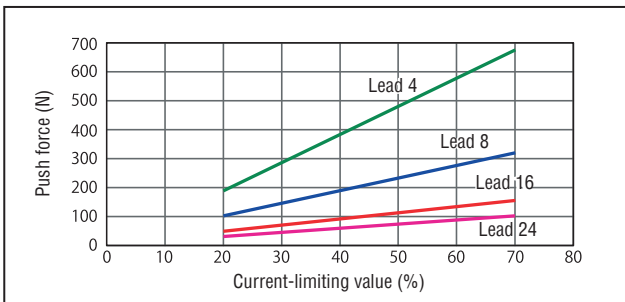

**RA7C type**

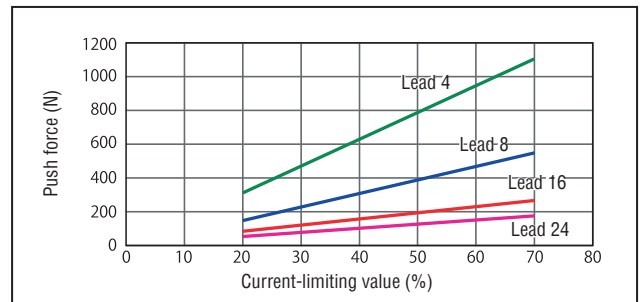

**RA8C/RA8R type**

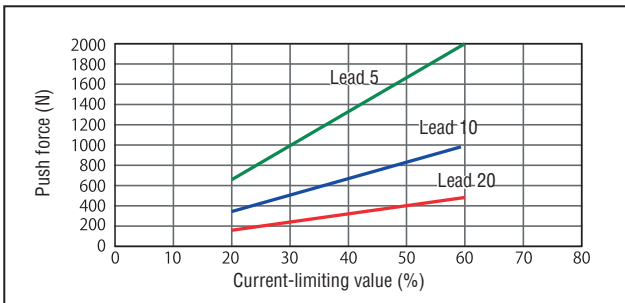

**RA10C/RA10R type**

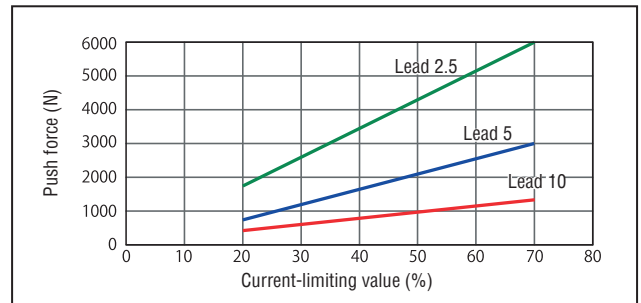

**Notes on Use**

- The relationship of push force and current-limiting value is only a reference, and the graphs may vary slightly from the actual values.
- If the current-limiting value is less than 20%, the push force may vary. Make sure the current-limiting value remains 20% or more.
- The graphs assume a traveling speed of 10 mm/s for RA8C/RA8R/RA10C/RA10R and 20 mm/s for other than those models during push-motion operation.
- Be sure to use the RA8C/RA8R at a current-limiting value of 60% or less, because performing push-motion operation with these actuators at a current-limiting value of 70% may lead to motor damage.
- Use the table below as a rough guide for the upper limit of push cycles when the RCP5-RA10C/RA10R of each lead is operated with the maximum push force over a push-motion travel distance of 1 mm.

Lead (type)	2.5	5	10
Push cycles	1.4 million cycles	25 million cycles	157.6 million cycles

\* The upper limit of push cycles varies depending on the impact, vibration and other operating conditions. The cycles shown to the left assume no impact or vibration.

**Points to Note on Push-motion Operation Using RCP5-RA10C/RA10R**

The push force is limited on certain RA10C/RA10R models due to its relationship with the buckling load of the ball screw. (Refer to the table below.)

Items	Stroke 550 mm or less	Stroke 600 mm or less	Stroke 650 mm or less	Stroke 700 mm or less	Stroke 750 mm or less	Stroke 800 mm or less
Lead 10	As shown in the push force graph					
Lead 5	As shown in the graph	2900 N	2500 N	2200 N	2000 N	1800 N
Lead 2.5	As shown in the graph					





# Selection **RCP5** series

## RCP5-RA10C

### Lead 2.5

Orientation	Horizontal
Speed (mm/s)	Acceleration (G)
0	300
42	300
63	300

Orientation	Vertical
Speed (mm/s)	Acceleration (G)
0	150
20	150
30	100
35	75
37	65
50	30
55	20
63	10

### Lead 5

Orientation	Horizontal
Speed (mm/s)	Acceleration (G)
0	150
83	150
125	150

Orientation	Vertical
Speed (mm/s)	Acceleration (G)
0	100
20	100
26	90
40	65
45	55
55	40
58	37
60	35
65	29
68	27
70	25
77	20
90	13
100	9
105	7
125	3

### Lead 10

Orientation	Horizontal
Speed (mm/s)	Acceleration (G)
0	80
100	80
175	80
200	80
225	38
240	20
250	15

Orientation	Vertical
Speed (mm/s)	Acceleration (G)
0	80
34	80
37	69
45	58
53	50
75	35
105	20
120	15
140	10
152	8
167	6

## RCP5-RA10R

### Lead 2.5

Orientation	Horizontal
Speed (mm/s)	Acceleration (G)
0	300
50	300

Orientation	Vertical
Speed (mm/s)	Acceleration (G)
0	0.01
20	150
30	95
35	70
37	60
50	6

### Lead 5

Orientation	Horizontal
Speed (mm/s)	Acceleration (G)
0	150
100	150

Orientation	Vertical
Speed (mm/s)	Acceleration (G)
0	100
20	100
26	90
40	65
45	55
55	40
58	37
60	35
65	29
68	27
70	25
77	20
90	13
100	9

### Lead 10

Orientation	Horizontal
Speed (mm/s)	Acceleration (G)
0	80
200	80

Orientation	Vertical
Speed (mm/s)	Acceleration (G)
0	80
34	80
37	69
45	58
53	50
75	35
105	20
120	15
140	10

## Selection References (Guide for Selecting Allowable Load for Radial Cylinder)

The radial cylinder has a built-in guide, so loads up to a certain level can be applied to the rod without using an external guide. Refer to the graphs below for the allowable load mass. If the allowable load will be exceeded under the required operating conditions, add an external guide.

### Allowable load mass for RCP5, horizontally mounted

【Horizontally mounted, laid flat】

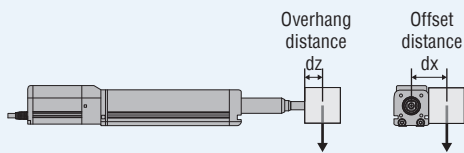

【Horizontally mounted, laid on it's side】

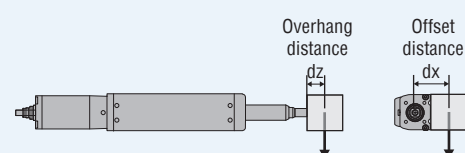

## RCP5-RA4/RA6/RA7

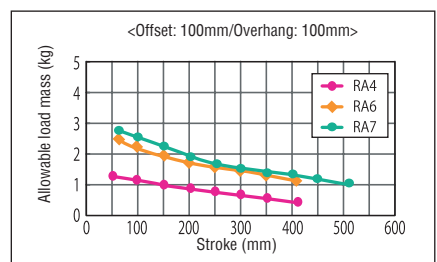
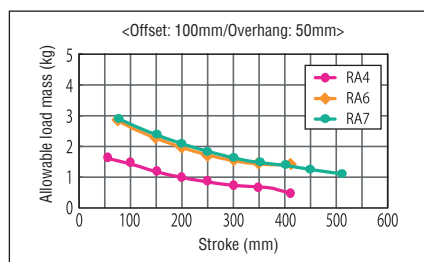
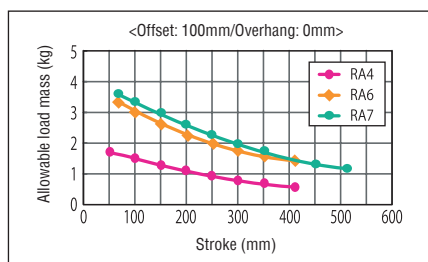
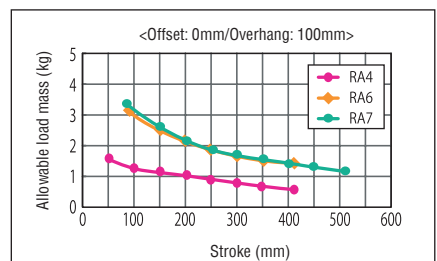
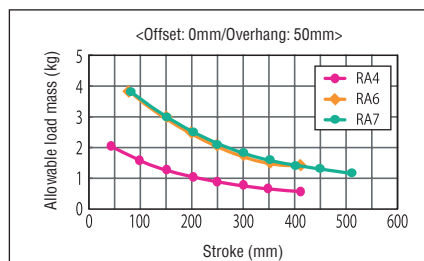
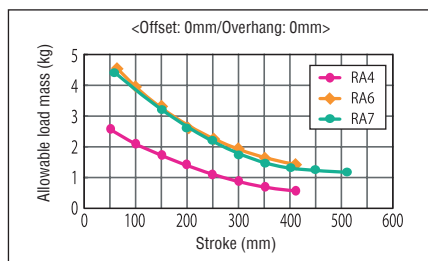

RCP5-RA8/RA10

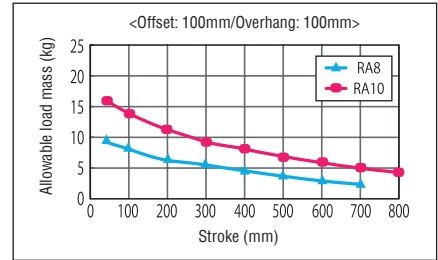
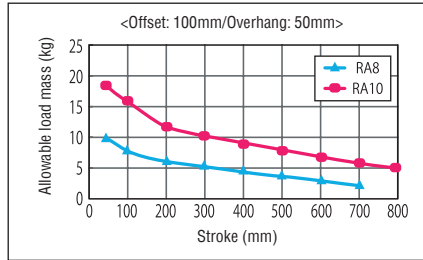
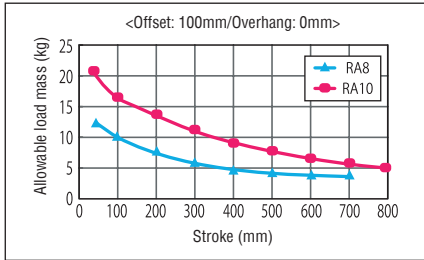
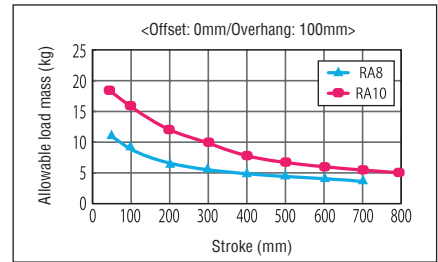
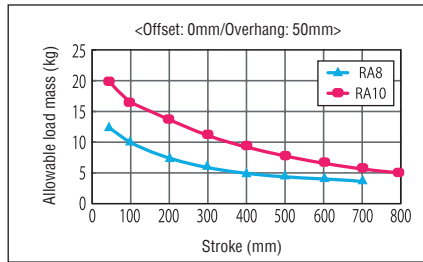
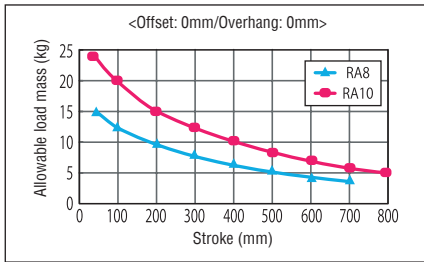

Allowable load mass for RCP5, vertically mounted

**【Vertically mounted】**

Allowable load calculation conditions.  
Load mass corresponding to a product traveling life of 5000 km, considering moments generated by acceleration/ deceleration.  
(Maximum speed in the specification of speed.)

RCP5-RA4

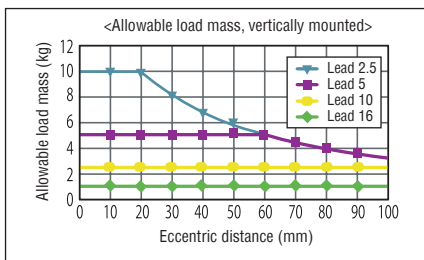

RCP5-RA6

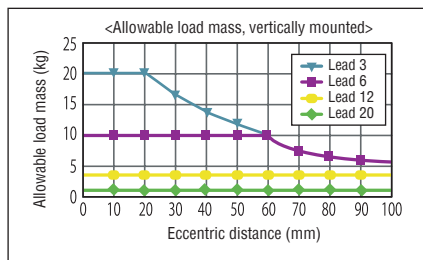

RCP5-RA7

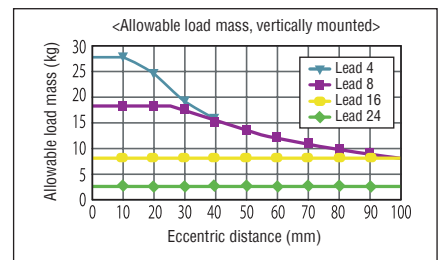

RCP5-RA8

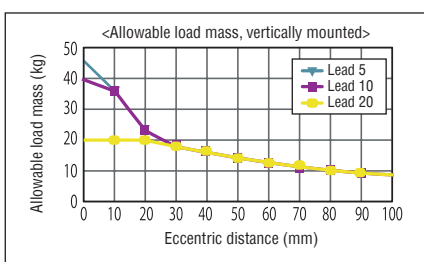

RCP5-RA10

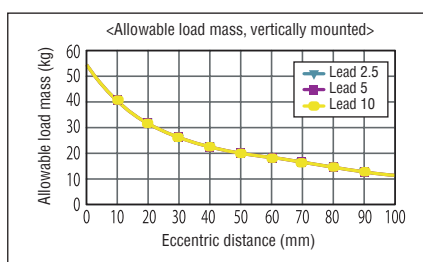

# System Configuration **RCP5** series

## System Configuration

### Single-axis Specification → Refer to P. 39

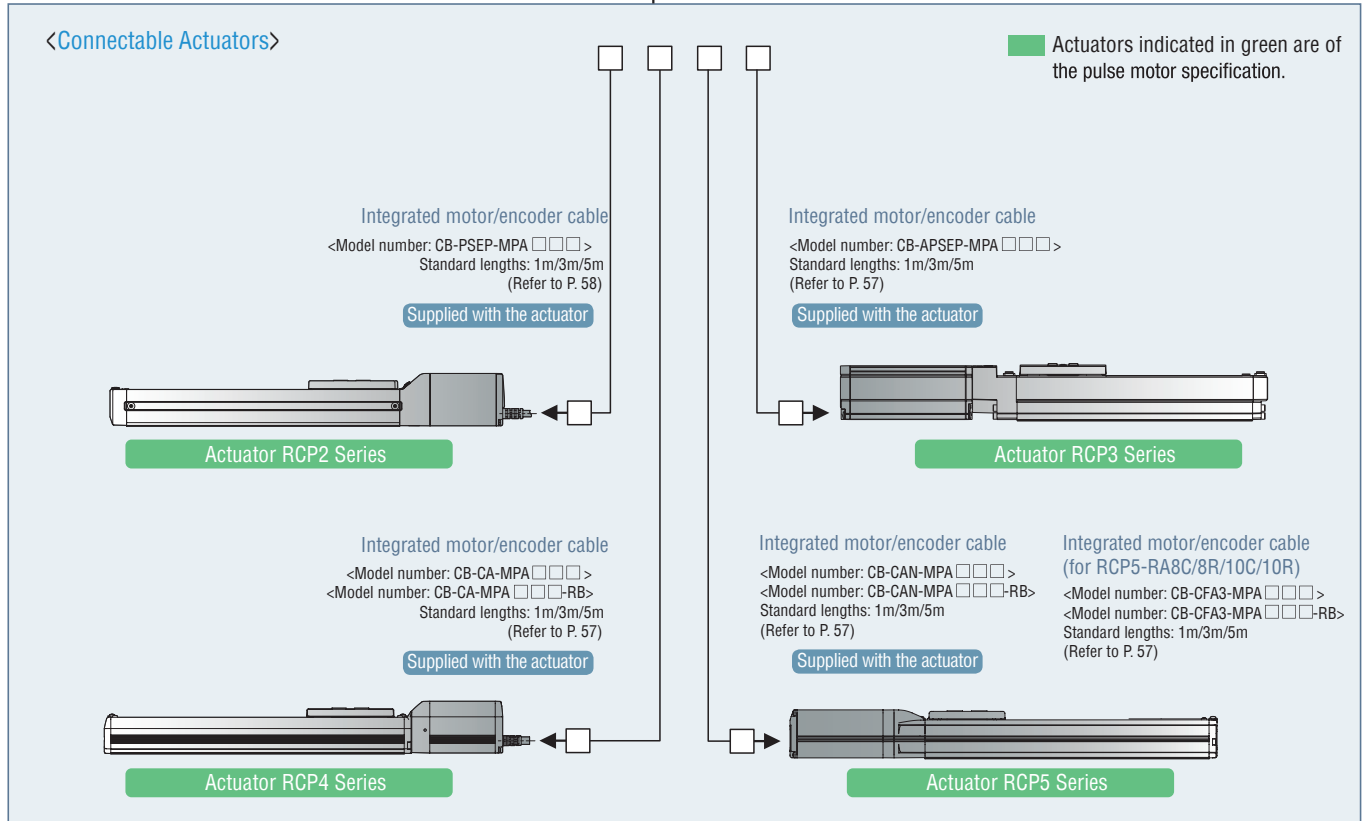
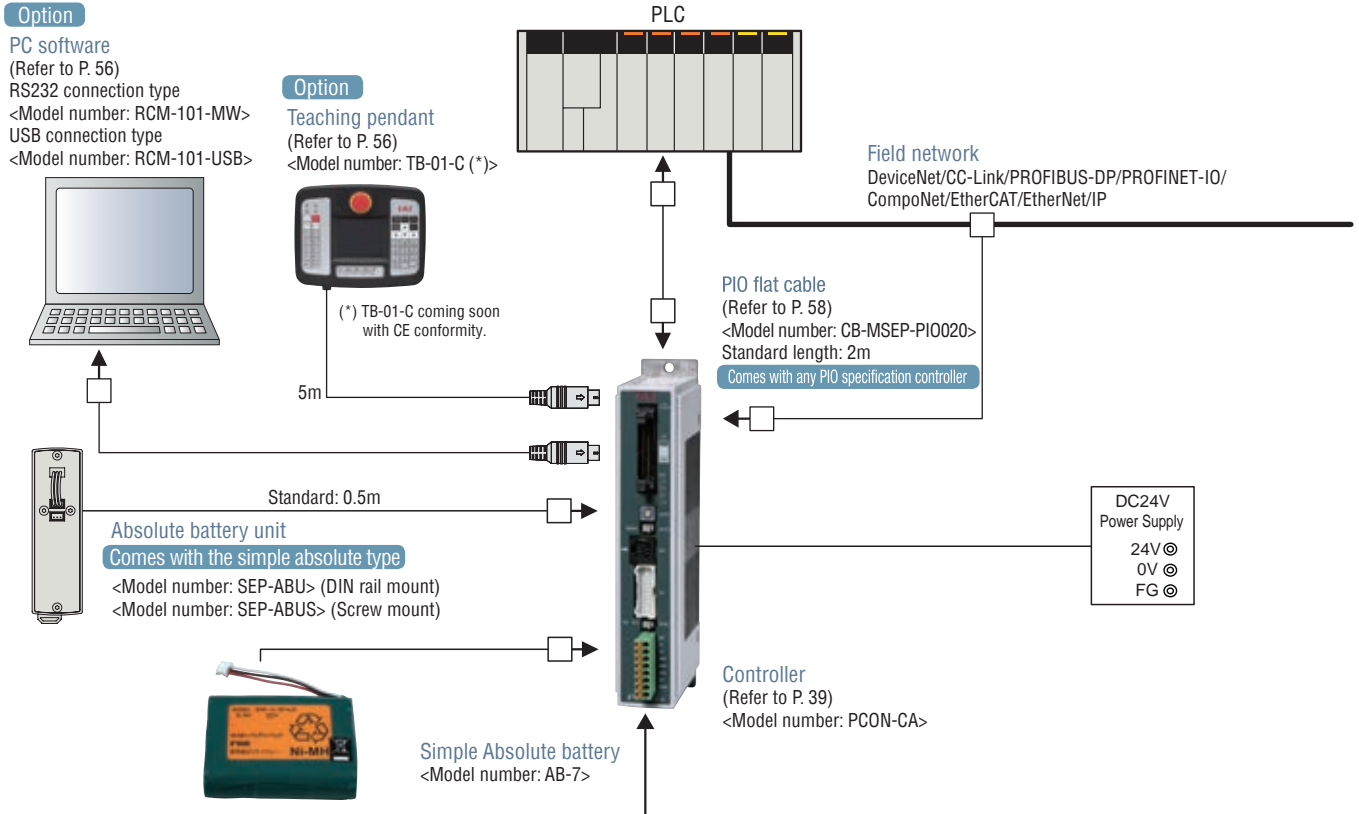

Multi-axis Specification (8-axis Specification/6-axis Specification with I/O Control Function)

→ Refer to P. 47

Option

PC software  
(Refer to P. 56)  
RS232 connection type  
<Model number: RCM-101-MW>  
USB connection type  
<Model number: RCM-101-USB>

\*The PowerCon (high-output driver) and Mini Cylinder are supported by Ver. 9.06.00.00 or later.



This cable comes with the PC software.

This cable comes with the absolute battery box.

Option

Absolute battery box  
<Model number: MSEP-ABB>  
Replacement battery  
<Model number: AB-7>

Option

Teaching pendant  
(Refer to P. 56)  
<Model number: TB-01-C (\*)>



(\* TB-01-C coming soon with CE conformity.)

\*If "Simple absolute type" is specified for the controller model, the controller will come with the absolute battery box. (Refer to P. 56 for the dimensions.)

PLC



Field network  
DeviceNet/CC-Link/PROFIBUS-DP/PROFINET-I/O/  
CompoNet/EtherCAT/EtherNet/IP

PIO flat cable  
(Refer to P. 58)  
<Model number: CB-MSEP-PIO020>  
Standard length: 2m  
Comes with any PIO specification controller.

\* You can choose either the PIO specification or field network specification for your controller.

\* To connect to a field network, you must set up the controller communications using the gateway parameter setting tool that comes with the PC software. Please purchase the PC software if you don't already have it.

\* Field network connection cables are the responsibility of the customer.

DC24V  
Power Supply  
24V ⊕  
0V ⊖  
FG ⊕

Controller

(Refer to P. 47)  
<Model number: MSEP-C>  
<Model number: MSEP-LC (\*)>

(\* MSEP-LC coming soon with CE conformity.)

<Connectable Actuators>

Integrated motor/encoder cable  
<Model number: CB-PSEP-MPA □□□>  
Standard lengths: 1m/3m/5m  
(Refer to P. 58)

Supplied with the actuator



Actuator RCP2 Series

\*The RCP2-RTBS/RTCS are excluded.

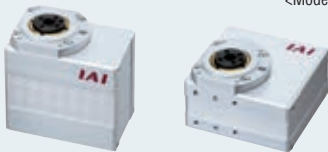

Actuator RCP2, Small Rotary  
(RCP2-RTBS/RTCS)

Integrated motor/encoder cable  
<Model number: CB-RPSEP-MPA □□□>  
Standard lengths: 1m/3m/5m  
(Refer to P. 58)

Supplied with the actuator

\*Exercise caution that rotary actuators of the 360-degree specification (RCP2-RT□SL/RT□L/RT□BL) are not supported.



Actuator RCP4 Series

Integrated robot motor/encoder cable  
<Model number: CB-CA-MPA □□□>  
<Model number: CB-CA-MPA □□□-RB>  
Standard lengths: 1m/3m/5m  
(Refer to P. 57)

Supplied with the actuator

Actuators indicated in green are of the pulse motor specification.  
Actuators indicated in blue are of the servo motor specification.  
Actuators indicated in orange are of the BLDC servo motor specification.

Integrated motor/encoder cable  
<Model number: CB-ASEP-MPA □□□>  
Standard lengths: 1m/3m/5m  
(Refer to P. 58)

Supplied with the actuator



Actuator RCA series

Integrated motor/encoder cable  
<Model number: CB-APSEP-MPA □□□>  
Standard lengths: 1m/3m/5m  
(Refer to P. 57)

Supplied with the actuator

Actuator RCP3 Series RCP2-GRSS/GRLS/GRST  
RCP2-SRA4R/SRGS4R/SRGD4R  
RCA2 Series RCL Series (Note 1)

(Note 1) Exercise caution that the RCL series does not support the simple absolute specification.

Integrated (robot) motor/encoder cable  
<Model number: CB-CAN-MPA □□□>  
<Model number: CB-CAN-MPA □□□-RB>  
Standard lengths: 1m/3m/5m  
(Refer to P. 57)

Supplied with the actuator

Integrated (robot) motor/encoder cable  
(for RCP5-RA8C/8R/10C/10R)  
<Model number: CB-CFA3-MPA □□□>  
<Model number: CB-CFA3-MPA □□□-RB>  
Standard lengths: 1m/3m/5m  
(Refer to P. 57)

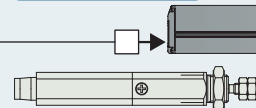

Actuator RCP5 Series  
RCD Series

Controller <PCON-CA/CFA> **RCP5** series



RCP5/RCP4 <PowerCon Type>  
RCP3/RCP2 Position Controllers

**1** Built-in high-output driver designed exclusively for RCP5/RCP4 generates greater torque at high speed

The newly developed high-output driver (patent pending) achieves significantly improved specifications compared to conventional models (RCP2 series), with the acceleration/deceleration higher by 1.4 times, maximum speed by 1.5 times, and payload twice as large.

(\*) The rates of improvement vary depending on the type.  
(\*) The RCP3/RCP2 are also supported.

Acceleration/ deceleration	RCP2	0.7G	1.4 times
	RCP5	1.0G	
Maximum speed	RCP2	1000mm/s	1.5 times
	RCP5	1440mm/s	
Payload	RCP2	6kg	2 times
	RCP5	12kg	

**2** Supporting the battery-less absolute encoder

The RCP5 equipped with a battery-less absolute encoder is supported. Since no battery is needed to retain position data, less space is needed to install the control panel, which in turn leads to lower cost of your equipment.



**3** Common boards ensures greater ease of maintenance

While conventional controllers require a separate set of boards for each actuator, the PCON-CA/CFA use common boards for all actuators, meaning that actuators of different models such as RCP5, RCP4, RCP3 and RCP2 can be operated simply by changing the controller settings. The result is significant reduction in maintenance stock.

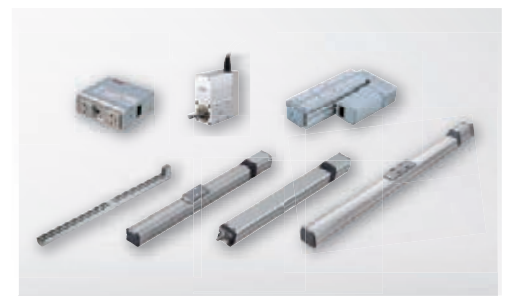

**4** Smart tuning function, maintenance information, calendar function

The takt time minimization function sets an optimal acceleration/deceleration rate according to the load that is available (\*). You can also record the number of times the actuator has moved and the distance that it has travelled, for use in maintenance.



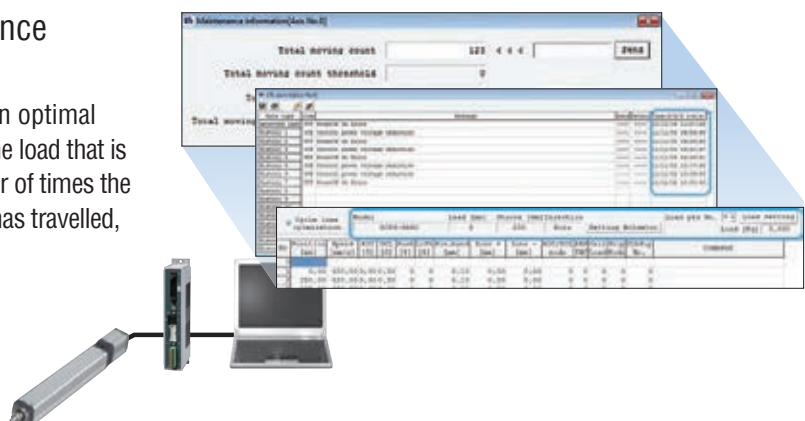



(\*) You need PC software Ver. 8.03.00.00 or later or a CON-PTA (teaching pendant) to use the takt time minimization function.





## List of Models

### RoboCylinder Position Controller

I/O type		Positioner type	Pulse-train type	Field network type						
										
				DeviceNet connection specification	CC-Link connection specification	PROFIBUS-DP connection specification	CompoNet connection specification	PROFINET-IO connection specification	EtherCAT connection specification	EtherNet/IP connection specification
I/O type model number		NP/PN	PLN/PLP	DV	CC	PR	CN	PRT	EC	EP
PCON-CA	Battery-less absolute specification or Incremental specification	○	○	○	○	○	○	○	○	○
	Simple absolute specification	with absolute battery	○	—	○	○	○	○	○	○
		with absolute battery unit	○	—	○	○	○	○	○	○
		No absolute battery	○	—	○	○	○	○	○	○
PCON-CFA	Battery-less absolute specification or Incremental specification	○	○	○	○	○	○	○	○	

\* If the RCP5 is used with pulse-train I/Os, the actuator must complete a home return prior to operation, as with any incremental actuator.

## Model Specification Items

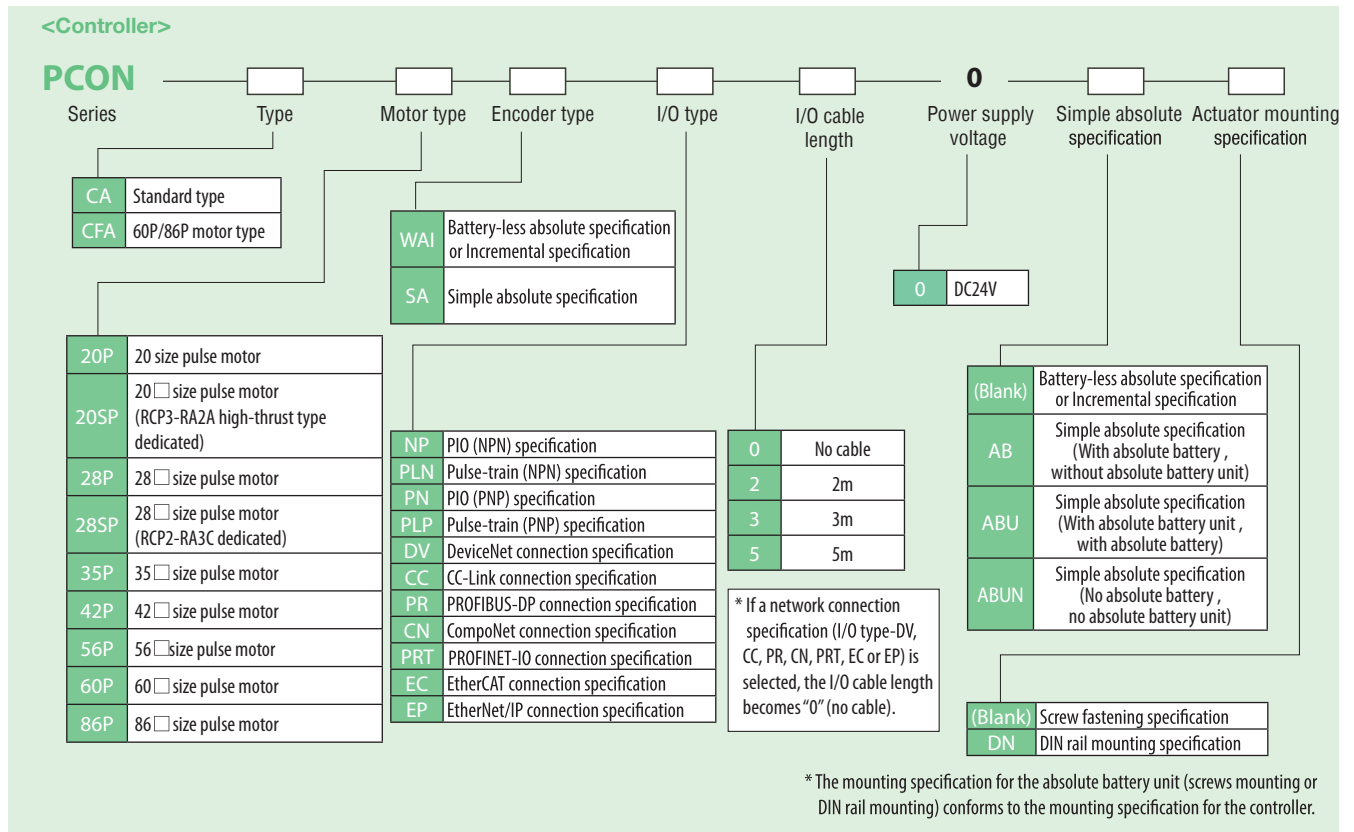

# Controller <PCON-CA/CFA> **RCP5** series

## PIO I/O Interface

### Input Part External Input Specifications

Item	Specification
Input voltage	DC24V ±10%
Input current	5 mA, 1 circuit
ON/OFF voltage	ON voltage: 18 VDC min. OFF voltage: 6 VDC max.

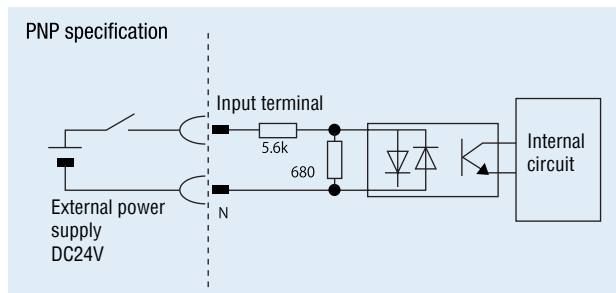
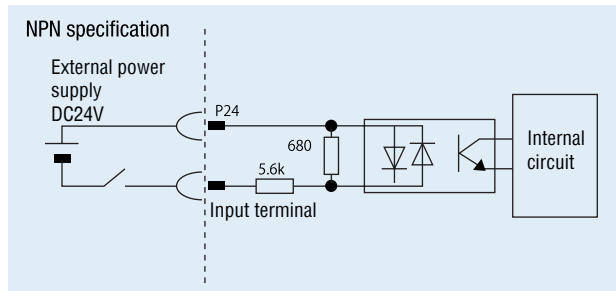

### Output Part External Output Specifications

Item	Specification
Load voltage	DC24V
Maximum load current	50 mA, 1 circuit
Leak current	2 mA max. per point

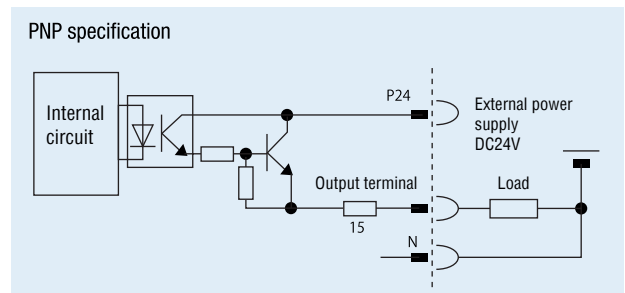
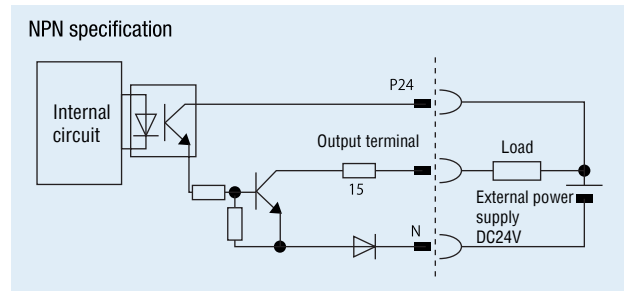

## Types of PIO Patterns (Control Patterns)

This controller supports seven types of control methods. Select in Parameter No. 25, "PIO pattern selection" the PIO pattern that best suits your purpose of use.

Type	Set value of Parameter No. 25	Mode	Overview
PIO pattern 0	0 (factory setting)	Positioning mode (standard type)	<ul style="list-style-type: none"> <li>Number of positioning points: 64 points</li> <li>Position number command: Binary Coded Decimal (BCD)</li> <li>Zone signal output (*1): 1 point</li> <li>Position zone signal output (*2): 1 point</li> </ul>
PIO pattern 1	1	Teaching mode (teaching type)	<ul style="list-style-type: none"> <li>Number of positioning points: 64 points</li> <li>Position number command: Binary Coded Decimal (BCD)</li> <li>Position zone signal output (*2): 1 point</li> <li>Jog (inching) operation using PIO signals is supported.</li> <li>Current position data can be written to the position table using PIO signals.</li> </ul>
PIO pattern 2	2	256-point mode (256 positioning points)	<ul style="list-style-type: none"> <li>Number of positioning points: 256 points</li> <li>Position number command: Binary Coded Decimal (BCD)</li> <li>Position zone signal output (*2): 1 point</li> </ul>
PIO pattern 3	3	512-point mode (512 positioning points)	<ul style="list-style-type: none"> <li>Number of positioning points: 512 points</li> <li>Position number command: Binary Coded Decimal (BCD)</li> <li>No zone signal output</li> </ul>
PIO pattern 4	4	Solenoid valve mode 1 (7-point type)	<ul style="list-style-type: none"> <li>Number of positioning points: 7 points</li> <li>Position number command: Individual number signal ON</li> <li>Zone signal output (*1): 1 point</li> <li>Position zone signal output (*2): 1 point</li> </ul>
PIO pattern 5	5	Solenoid valve mode 2 (3-point type)	<ul style="list-style-type: none"> <li>Number of positioning points: 3 points</li> <li>Position number command: Individual number signal ON</li> <li>Completion signal: A signal equivalent to a LS (limit switch) signal can be output.</li> <li>Zone signal output (*1): 1 point</li> <li>Position zone signal output (*2): 1 point</li> </ul>
PIO pattern 6 (Note 1)	6	Pulse-train control mode	<ul style="list-style-type: none"> <li>Differential pulse input (200 kpps max.)</li> <li>Home return function</li> <li>Zone signal output (*1): 2 points</li> <li>No feedback pulse output</li> </ul>

(\*1) Zone signal output: A desired zone is set by Parameter Nos. 1 and 2 or 23 and 24, and the set zone always remains effective once home return has completed.

(\*2) Position zone signal output: This function is available as part of a position number. A desired zone is set in the position table and becomes effective only when the corresponding position is specified, but not with commands specifying other positions.

(Note 1) Pulse Train Control Model is available only if the pulse train control type is indicated (from PCON-CA-PLN and PLP) at the time of purchase.

## PIO Patterns and Signal Assignments

The table below lists the signal assignments for the I/O flat cable under different PIO patterns. Connect an external device (such as a PLC) according to this table.

Pin number	Category	PIO function	Parameter No. 25, "PIO pattern selection"					
			0	1	2	3	4	5
			Positioning mode	Teaching mode	256-point mode	512-point mode	Solenoid valve mode 1	Solenoid valve mode 2
	Input	Number of positioning points	64 points	64 points	256 points	512 points	7 points	3 points
		Home return signal	○	○	○	○	○	—
		Jog signal	—	○	—	—	—	—
		Teaching signal (writing of current position)	—	○	—	—	—	—
	Output	Brake release	○	—	○	○	○	○
		Moving signal	○	○	—	—	—	—
		Zone signal	○	△ (Note 1)	△ (Note 1)	—	○	○
		Position zone signal	○	○	○	—	○	
1A	24V	P24						
2A	24V	P24						
3A	Pulse input	—						
4A		—						
5A	Input	IN0	PC1	PC1	PC1	PC1	ST0	ST0
6A		IN1	PC2	PC2	PC2	PC2	ST1	ST1(JOG+)
7A		IN2	PC4	PC4	PC4	PC4	ST2	ST2(-)
8A		IN3	PC8	PC8	PC8	PC8	ST3	—
9A		IN4	PC16	PC16	PC16	PC16	ST4	—
10A		IN5	PC32	PC32	PC32	PC32	ST5	—
11A		IN6	—	MODE	PC64	PC64	ST6	—
12A		IN7	—	JISL	PC128	PC128	—	—
13A		IN8	—	JOG+	PC256	PC256	—	—
14A		IN9	BKRL	JOG-	BKRL	BKRL	BKRL	BKRL
15A		IN10	RMOD	RMOD	RMOD	RMOD	RMOD	RMOD
16A		IN11	HOME	HOME	HOME	HOME	HOME	—
17A		IN12	*STP	*STP	*STP	*STP	*STP	—
18A		IN13	CSTR	CSTR/PWRT	CSTR	CSTR	—	—
19A		IN14	RES	RES	RES	RES	RES	RES
20A	IN15	SON	SON	SON	SON	SON	SON	
1B	Output	OUT0	PM1(ALM1)	PM1(ALM1)	PM1(ALM1)	PM1(ALM1)	PE0	LS0
2B		OUT1	PM2(ALM2)	PM2(ALM2)	PM2(ALM2)	PM2(ALM2)	PE1	LS1(TRQS)
3B		OUT2	PM4(ALM4)	PM4(ALM4)	PM4(ALM4)	PM4(ALM4)	PE2	LS2 (Note2)
4B		OUT3	PM8(ALM8)	PM8(ALM8)	PM8(ALM8)	PM8(ALM8)	PE3	—
5B		OUT4	PM16	PM16	PM16	PM16	PE4	—
6B		OUT5	PM32	PM32	PM32	PM32	PE5	—
7B		OUT6	MOVE	MOVE	PM64	PM64	PE6	—
8B		OUT7	ZONE1	MODES	PM128	PM128	ZONE1	ZONE1
9B		OUT8	PZONE/ZONE2	PZONE/ZONE1	PZONE/ZONE1	PM256	PZONE/ZONE2	PZONE/ZONE2
10B		OUT9	RMDS	RMDS	RMDS	RMDS	RMDS	RMDS
11B		OUT10	HEND	HEND	HEND	HEND	HEND	HEND
12B		OUT11	PEND	PEND/WEND	PEND	PEND	PEND	—
13B		OUT12	SV	SV	SV	SV	SV	SV
14B		OUT13	*EMGS	*EMGS	*EMGS	*EMGS	*EMGS	*EMGS
15B		OUT14	*ALM	*ALM	*ALM	*ALM	*ALM	*ALM
16B	OUT15	LOAD/TRQS *ALML	*ALML	LOAD/TRQS *ALML	LOAD/TRQS *ALML	LOAD/TRQS *ALML	*ALML	
17B	Pulse input	—						
18B		—						
19B	0V	N						
20B	0V	N						

(Note) In the table above, asterisk symbol "\*" accompanying each code indicates a negative logic signal. PM1 to PM8 are alarm binary code output signals that are used when an alarm generates.

(Note 1) In all PIO patterns other than 3, this signal can be switched with PZONE by setting Parameter No. 149 accordingly.

(Note 2) The setting will not become effective until the home return is completed.

### Reference) Negative logic signal

Signals denoted by "\*" are negative logic signals. Negative logic input signals are processed when turned OFF. Negative logic output signals normally remain ON while the power is supplied, and turn OFF when the signal is output. Note: The names of the signals above inside "(" ) are functions before the unit returns home.

# Controller <PCON-CA/CFA> **RCP5** series

## Pulse-train Control Circuit

### ■ Host Unit = Differential Type

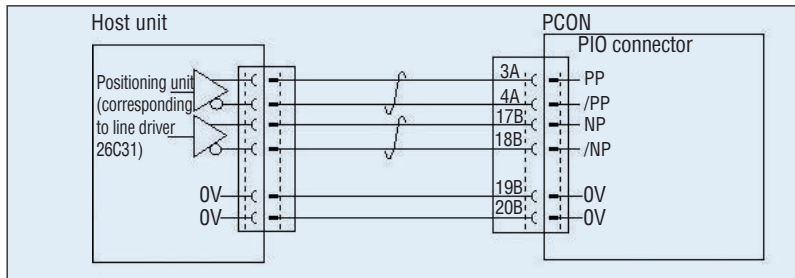

### ■ Host Unit = Open Collector Type The AK-04 (optional) is needed to input pulses.

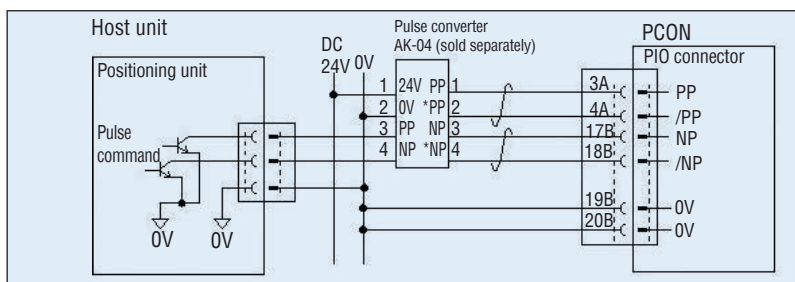

**⚠ Caution: Use the same power supply for open collector input/output to/from the host and for the AK-04.**

## Command Pulse Input Patterns

	Command pulse-train pattern	Input terminal	Forward	Reverse	
Negative logic	Forward pulse-train	PP·/PP			
	Reverse pulse-train	NP·/NP			
	A forward pulse-train indicates the amount of motor rotation in the forward direction, while a reverse pulse-train indicates the amount of motor rotation in the reverse direction.				
	Pulse-train	PP·/PP			
	Sign	NP·/NP	Low	High	
	The command pulses indicate the amount of motor rotation, while the sign indicates the rotating direction.				
Positive logic	Forward pulse-train	PP·/PP			
	Reverse pulse-train	NP·/NP			
	Command phases A and B having a 90° phase difference (multiplier is 4) indicate the amount of rotation and the rotating direction.				
	Pulse-train	PP·/PP			
	Sign	NP·/NP	High	Low	
	The command phases indicate the amount of motor rotation, while the sign indicates the rotating direction.				

## I/O Signals in Pulse-train Control Mode

The table below lists the signal assignments for the flat cable in the pulse-train control mode. Connect an external device (such as PLC) according to this table.

Pin number	Category	I/O number	Signal abbreviation	Signal name	Function description
1A	24V		P24	Power supply	I/O power supply +24 V
2A	24V		P24	Power supply	I/O power supply +24 V
3A	Pulse input		PP	Differential pulse-train input (+)	Differential pulses are input from the host. Up to 200 kpps can be input.
4A			/PP	Differential pulse-train input (-)	
5A	Input	N0	SON	Servo ON	The servo is ON while this signal is ON, and OFF while the signal is OFF.
6A		IN1	RES	Reset	Present alarms are reset when this signal is turned ON.
7A		IN2	HOME	Home return	Home return operation is performed when this signal is turned ON.
8A		IN3	TL	Torque limit selection	When this signal is turned ON, the motor torque is limited to the value set by the parameter.
9A		IN4	CSTP	Forced stop	The actuator is forcibly stopped when this signal has remained ON for 16 ms or more. The actuator decelerates to a stop at the torque set in the controller and the servo turns OFF.
10A		IN5	DCLR	Deviation counter clear	This signal clears the deviation counter.
11A		IN6	BKRL	Forced brake release	The brake is forcibly released.
12A		IN7	RMOD	Operation mode switching	The operation mode can be switched when the MODE switch on the controller is set to AUTO. (AUTO when this signal is OFF, and to MANU when the signal is ON.)
13A		IN8	NC	—	Not used
14A		IN9	NC	—	Not used
15A		IN10	NC	—	Not used
16A		IN11	NC	—	Not used
17A		IN12	NC	—	Not used
18A		IN13	NC	—	Not used
19A		IN14	NC	—	Not used
20A	IN15	NC	—	Not used	
1B	Output	OUT0	PWR	System ready	This signal turns ON when the controller becomes ready after the main power has been turned on.
2B		OUT1	SV	Servo ON status	This signal turns ON when the servo is ON.
3B		OUT2	INP	Positioning complete	This signal turns ON when the amount of remaining travel pulses in the deviation counter falls within the in-position band.
4B		OUT3	HEND	Home return complete	This signal turns ON upon completion of home return.
5B		OUT4	TLR	Torque limited	This signal turns ON upon reaching the torque limit while the torque is limited.
6B		OUT5	*ALM	Controller alarm status	This signal turns ON when the controller is normal, and turns OFF when an alarm generates.
7B		OUT6	*EMGS	Emergency stop status	This signal turns ON when the emergency stop of the controller is cancelled, and turns OFF when an emergency stop is actuated.
8B		OUT7	RMDS	Operation mode status	The operation mode status is output. This signal turns ON when the controller is in the manual mode.
9B		OUT8	ALM1	Alarm code output signal	An alarm code is output when an alarm generates. For details, refer to the operation manual.
10B		OUT9	ALM2		
11B		OUT10	ALM4		
12B		OUT11	ALM8		
13B		OUT12	*ALML	Minor failure alarm	This signal is output when a message-level alarm generates.
14B		OUT13	NC	—	Not used
15B		OUT14	ZONE1	Zone signal 1	This signal turns ON when the current position of the actuator falls within the parameter-set range.
16B	OUT15	ZONE2	Zone signal 2		
17B	Pulse input		NP	Differential pulse-train input (+)	Differential pulses are input from the host. Up to 200 kpps can be input.
18B			/NP	Differential pulse-train input (-)	
19B	0V		N	Power supply	I/O power supply 0 V
20B	0V		N	Power supply	I/O power supply 0 V

(Note) "\*" indicates a negative logic signal. Negative logic signals are normally ON while the power is supplied, and turn OFF when the signal is output.

(Note) The number of encoder pulses is 800 with all RCP5 series models. For details, refer to the operation manual.

## Controller <PCON-CA/CFA> **RCP5** series

### Field Network Specification: Explanation of Operation Modes

If the PCON-CA is controlled via a field network, you can select one of the following five modes to operate the actuator. Take note that the required data areas on the PLC side vary depending on the mode.

#### Mode Description

	Mode	Description
0	Remote I/O mode	In this mode, the actuator is operated by controlling the ON/OFF of bits via the network, just like with the PIO specification. The number of positioning points and functions vary with each of the operation patterns (PIO patterns) that can be set by the controller's parameter.
1	Position/simple direct numerical mode	The target position is specified by directly entering a value, while other operating conditions (speed, acceleration, etc.) are set by specifying the desired position number corresponding to the desired operating conditions already input to the position data table.
2	Half direct numerical mode	The actuator is operated by specifying the speed, acceleration/deceleration and push current, in addition to the target position, by directly entering values.
3	Full direct numerical mode	The actuator is operated by specifying the target position, speed, acceleration/deceleration, push current control value, etc., by directly entering values. The current position, current speed, command current, etc., can also be read.
4	Remote I/O mode 2	Same as the above remote I/O mode, plus the current position read function and command current read function.

#### Required Data Size for Each Network

		DeviceNet	CC-Link	PROFIBUS-DP	CompoNet	PROFINET-IO	EtherCAT	EtherNet/IP
0	Remote I/O mode	1CH	1 station	2 bytes	2 bytes	2 bytes	2 bytes	2 bytes
1	Position/simple direct numerical mode	4CH	1 station	8 bytes	8 bytes	8 bytes	8 bytes	8 bytes
2	Half direct numerical mode	8CH	2 stations	16 bytes	16 bytes	16 bytes	16 bytes	16 bytes
3	Full direct numerical mode	16CH	4 stations	32 bytes	32 bytes	32 bytes	32 bytes	32 bytes
4	Remote I/O mode 2	6CH	1 station	12 bytes	12 bytes	12 bytes	12 bytes	12 bytes

#### List of Functions by Operation Mode

	Remote I/O mode	Position/simple direct numerical mode	Half direct numerical mode	Full direct numerical mode	Remote I/O mode 2
Number of positioning points	512 points	768 points	Unlimited	Unlimited	512 points
Operation by direct position data specification	—	○	○	○	—
Direct speed/acceleration specification	—	—	○	○	—
Push-motion operation	○	○	○	○	○
Current position read	—	○	○	○	○
Current speed read	—	—	○	○	—
Operation by position number specification	○	○	—	—	○
Completed position number read	○	○	—	—	○

\* "○" indicates that the operation is supported, and "—" indicates that it is not supported.

## External Dimensions

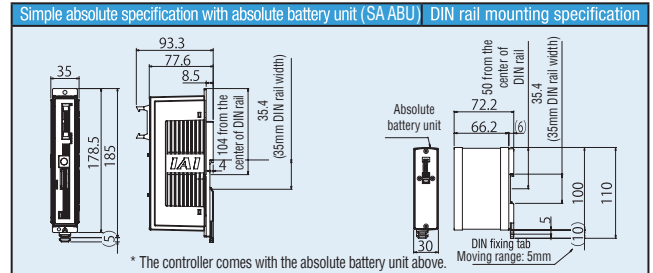
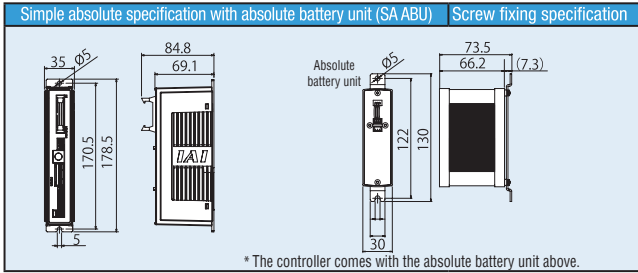
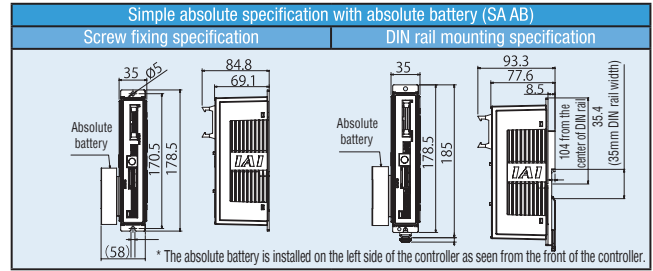
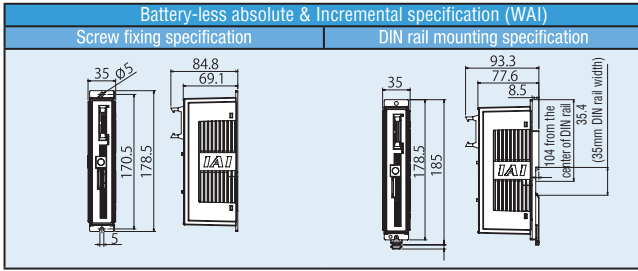

### PCON-CFA

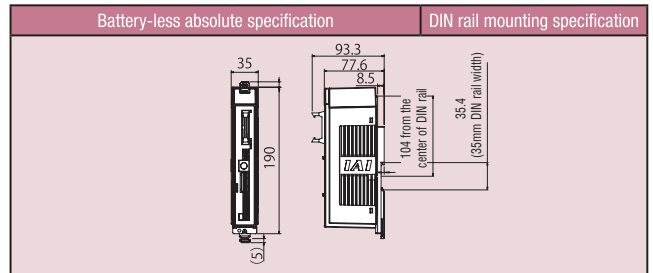
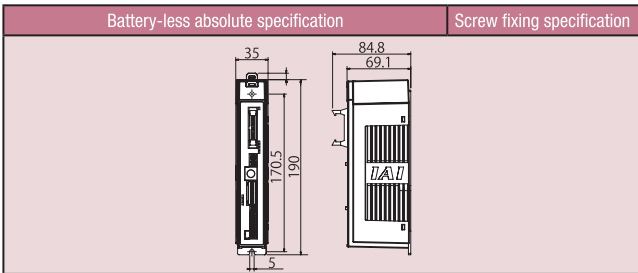

## Specification List

Item		Description	
		PCON-CA	PCON-CFA
Number of controlled axes		1 axis	
Power-supply voltage		DC24V±10%	
Load current (including control-side current consumption) (Note 1)	RCP2 RCP3	Motor type	20P, 28P, 28SP 42P, 56P 60P, 86P
		Motor type	28P, 35P, 42P, 56P 60P, 86P
	RCP4 RCP5	Motor type	High-output setting disabled: 2.2 A max. High-output setting enabled: 3.5 A rated / 4.2 A max.
		Motor type	6 A max
Electromagnetic brake power (for actuator with brake)		DC24V ±10% 0.15A (max)	DC24V ±10% 0.5A (max)
Rush current (Note 2)		8.3A	
Momentary power failure resistance		MAX.500µs	
Supported encoder		Battery-less absolute encoder/incremental encoder	
Actuator cable length		20m max.	
External interface	PIO specification	Dedicated 24-VDC signal inputs/outputs (NPN/PNP selectable) --- Up to 16 input points, up to 16 output points, cable length up to 10m	
	Field network specification	DeviceNet, CC-Link, PROFIBUS-DP, CompoNet, PROFINET-IO, EtherCAT, EtherNet/IP	
Data setting, input method		PC software, touch panel teaching pendant, teaching pendant	
Data retention memory		Position data and parameters are saved in non-volatile memory. (There are no limits to how many times the memory can be rewritten.)	
Operation mode		Positioner mode/pulse-train control mode (selectable by parameter setting)	
Number of positioner-mode positions		Up to 512 points for positioner type or up to 768 points for network type (Note) The total number of positioning points varies depending on which PIO pattern is selected.	
Pulse-train interface	Input pulses	Differential type (line-driver type): 200 kpps max., cable length up to 10m	
		Open-collector type: Not supported. * If the host uses open-collector outputs, use the separately sold AK-04 (optional) to change them to differential outputs.	
	Command pulse magnification (Electronic gear: A/B)	1/50 < A/B < 50/1 Setting range of A and B (set by parameters): 1 to 4096	
	Feedback pulse output	None	
Insulation resistance		Not less than 10 MΩ at 500 VDC.	
Electric shock protection mechanism		Class I, basic insulation	
Mass (Note 3)	Incremental specification	Screw fixing type: Not more than 250g / DIN rail fixing type: Not more than 285g	Screw fixing type: Not more than 270g / DIN rail fixing type: Not more than 305g
	Simple absolute specification (including 190 g for battery)	Screw fixing type: Not more than 450g / DIN rail fixing type: Not more than 485g	
Cooling method		Natural cooling by air	Forced cooling by air
Environment	Ambient operating temperature	0 to 40°C	
	Ambient operating humidity	Not more than 85% RH (non-condensing)	
	Operating ambience	Free from corrosive gases	
	Degree of protection	IP20	

Note 1) 0.3 A higher for the field network specification.

Note 2) Rush current flows for approx. 5 msec after the power is input (at 40°C). Exercise caution that the rush current value varies depending on the impedance of the power line.

Note 3) 30 g heavier for the field network specification.

Controller <MSEP-C/LC> **RCP5** series

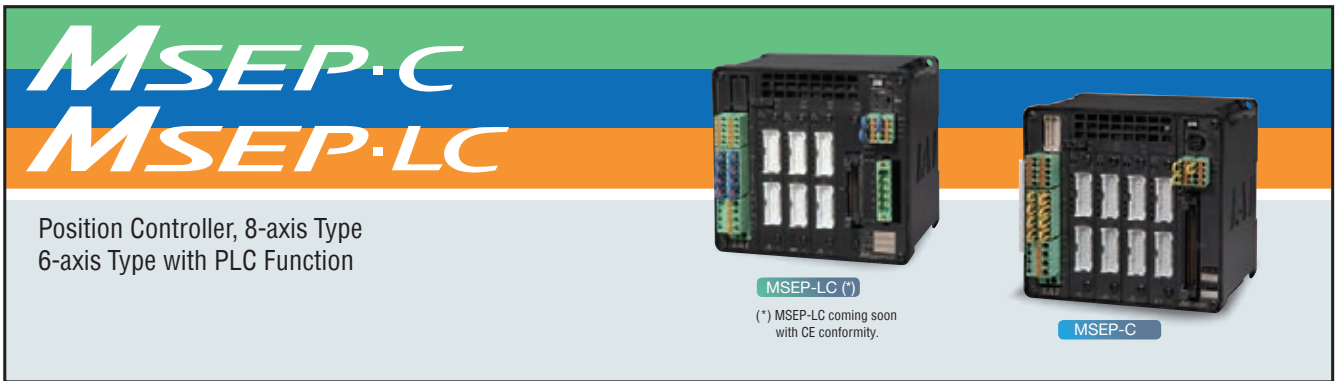

# 1 Added PLC function

**MSEP-LC (\*)** (\*) MSEP-LC coming soon with CE conformity.

Operating the actuator and controlling the ON/OFF of I/O (input/output) signals using a ladder logic program is now possible. If your equipment is small enough, the MSEP-LC is all you need to control it. If your equipment is larger in size, you can still use the MSEP-LC to perform distributed control for each process to reduce the load of the main PLC. The MSEP-LC also makes your program simpler and troubleshooting easier.

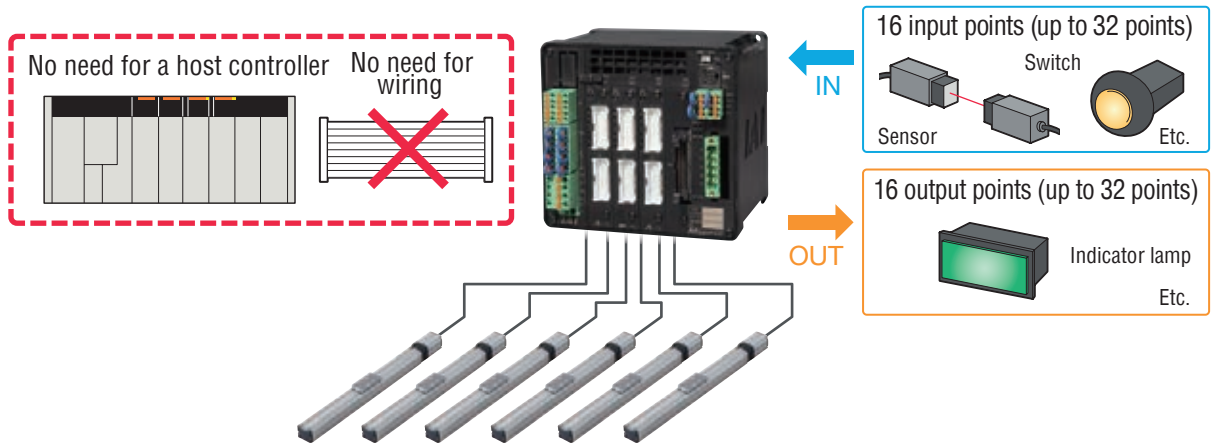

# 2 Supporting actuators with the battery-less absolute encoder

**MSEP-LC (\*)** **MSEP-C** (\*) MSEP-LC coming soon with CE conformity.

Features of actuators with the battery-less absolute encoder

- 1 Home return is no longer necessary, so these actuators start and restart quicker than incremental actuators to begin working right away. They are also free from problems relating to home return, such as position shift.
- 2 Compared to standard absolute actuators, no battery is required, which results in the following benefits:
  - ▶ No need to purchase or replace batteries
  - ▶ No need to control the stocks and replacement timing of batteries
  - ▶ No need to make adjustment (absolute reset) normally required after battery replacement

RoboCylinder with the battery-less absolute encoder

**RCP5**





# 3 Supporting the PowerCon (high-output driver) and Mini Cylinder

MSEP-LC (\*) MSEP-C (\*) MSEP-LC coming soon with CE conformity.

When the PowerCon (newly developed high-output driver) is installed and combined with the RCP5 or RCP4, high performance is realized as indicated by the maximum speed of 1.5 times higher than that of conventional models and payload of more than twice.

Since the super-compact Mini Cylinders are also supported, you have a greater range of actuator variations - from small to large - to choose from.

Max. speed vs. conventional models **1.5 times higher**

Payload vs. conventional models **More than twice**

PowerCon supported  
RCP5-SA RCP5-RA

Mini Cylinder  
RCD-RA

Choice of 6 boards to install

- 1 Pulse motor board
- NEW** 2 Pulse motor board for battery-less absolute specification
- NEW** 3 PowerCon (pulse high-output motor) board
- NEW** 4 PowerCon board for battery-less absolute specification
- 5 AC servo motor board
- NEW** 6 Mini Cylinder (DC servo motor) board

\* Boards **3** and **4** permit operation of only one axis per board.

# 4 Supporting field networks

MSEP-LC (\*) MSEP-C (\*) MSEP-LC coming soon with CE conformity.

DeviceNet, CC-Link, PROFIBUS-DP, CompoNet, EtherCAT, EtherNet/IP, PROFINET-IO and other major field networks are directly accessible.

## Features of the network specification

- ▶ 256 positioning points per axis
- ▶ Numerically specify the target position or speed to move to
- ▶ Checking the current position in real time
- ▶ Substantially shorter communications time inside the controller (approx. one-tenth of conventional models)

DeviceNet PROFI BUS

CompoNet CC-Link

EtherNet/IP EtherCAT

PROFI NET

# 5 Free ladder logic support software is downloadable from our website

MSEP-LC (\*) (\*) MSEP-LC coming soon with CE conformity.

Ladder support software is available for free download from our website. You can create a ladder program before purchasing any product.

Available Soon

[Free] [www.robocylinder.de](http://www.robocylinder.de) -> download -> software

LC-LADDER

Controller <MSEP-C/LC> **RCP5** series

Application Examples

**Rear panel positioning system**

Shifted work parts are aligned by the “push motion” of the RoboCylinder as they enter the machining stage for automotive rear panels. One controller can handle multiple axes, so wiring is easy.

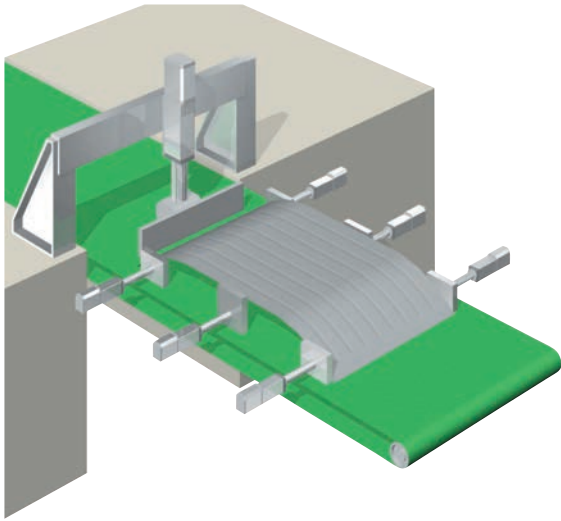

**Palletizing system**

Should the system halt due to an emergency stop, etc., it can resume operation right away thanks to the battery-less absolute encoder.

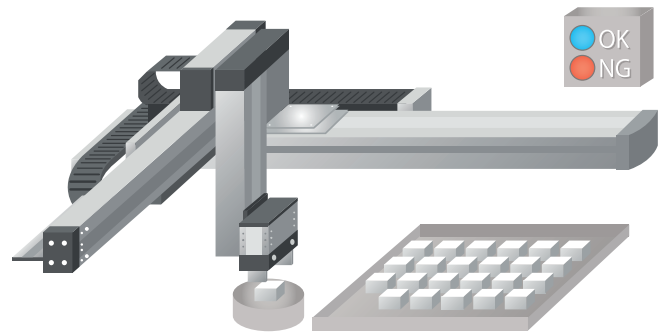

**Transferring work parts between machining systems**

Work parts can be transferred between systems without using a dedicated PLC.

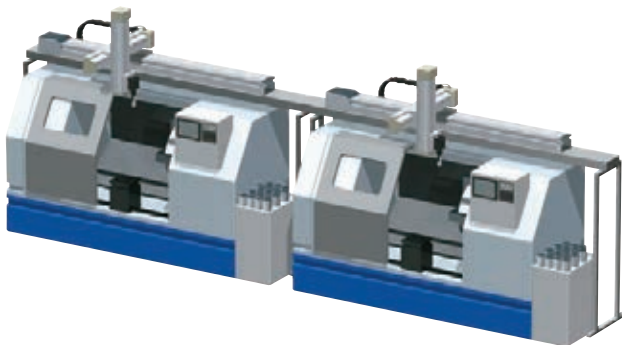

**Positioning on an automotive manufacturing line**

In the case of a large-scale line, implementing distributed control of each process and connecting to the host controller via a field network reduces the control load of the host controller.

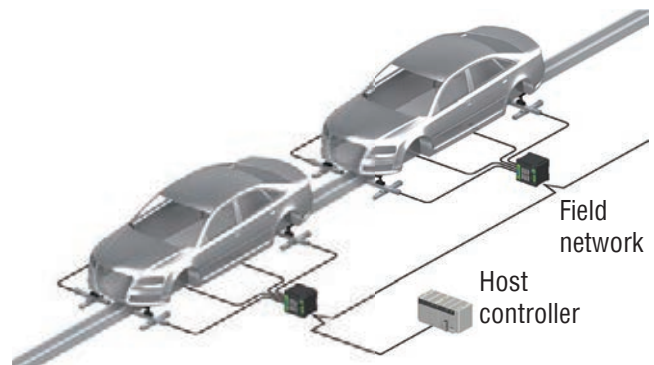

# MSEP Controller Models

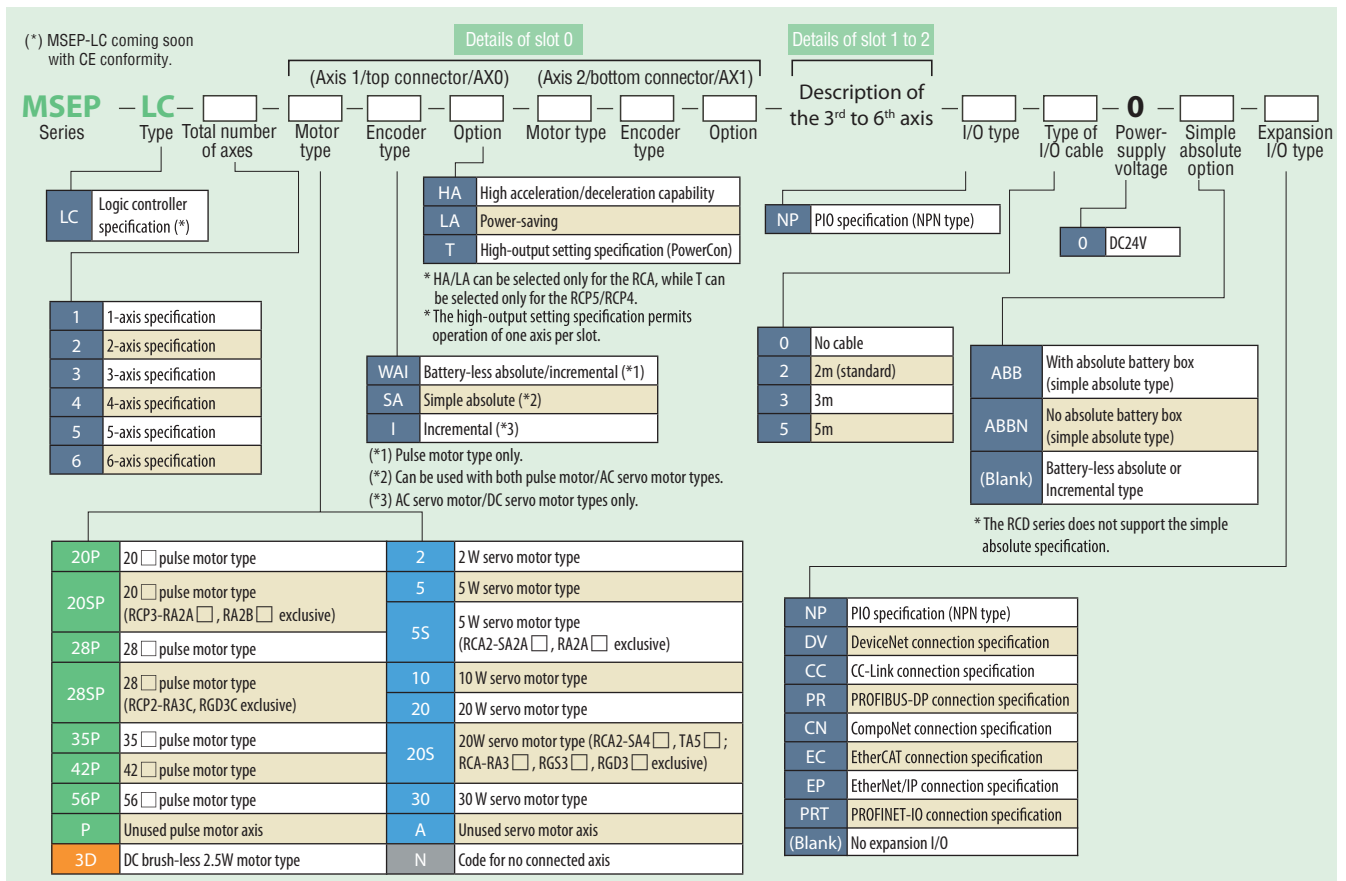
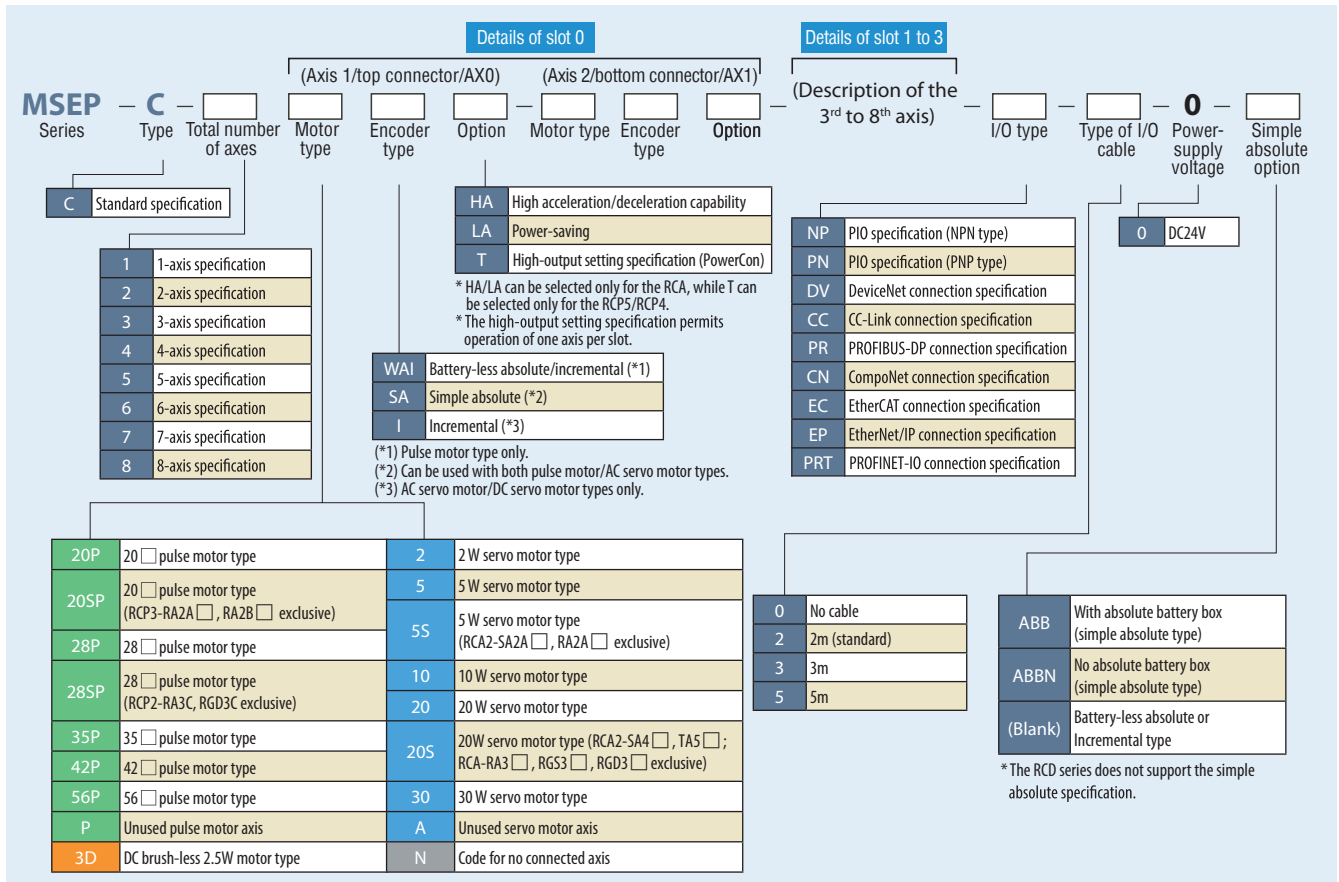

# Controller <MSEP-C/LC> **RCP5** series

## How to Operate the MSEP-C

### PIO Specification

Input position data to the MSEP-C and specify a desired position number via PIO from the host PLC to operate the actuator.

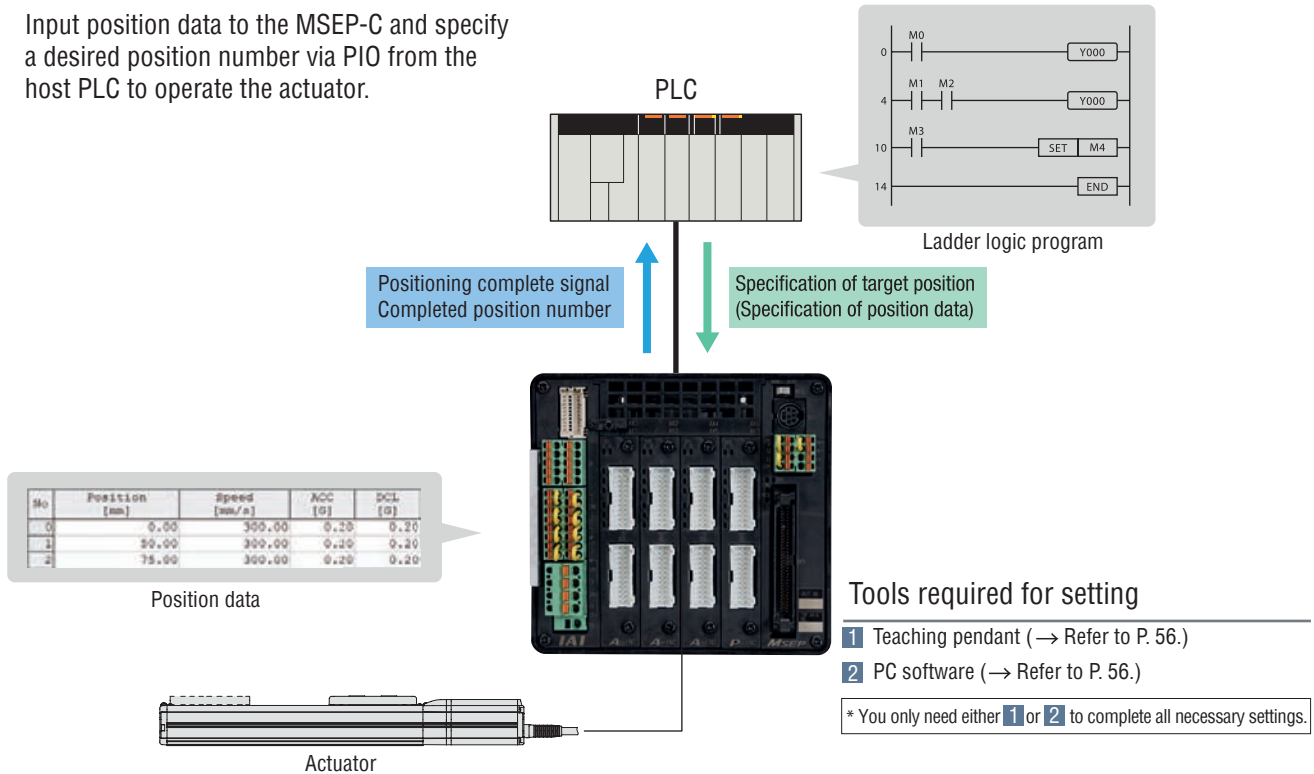

### Field Network Specification

- 1 As with the PIO specification, input position data to the MSEP and specify a desired position number via a field network from the PLC to operate the actuator.
- 2 The PLC sends numerical position, speed and other data via a field network to operate the actuator.

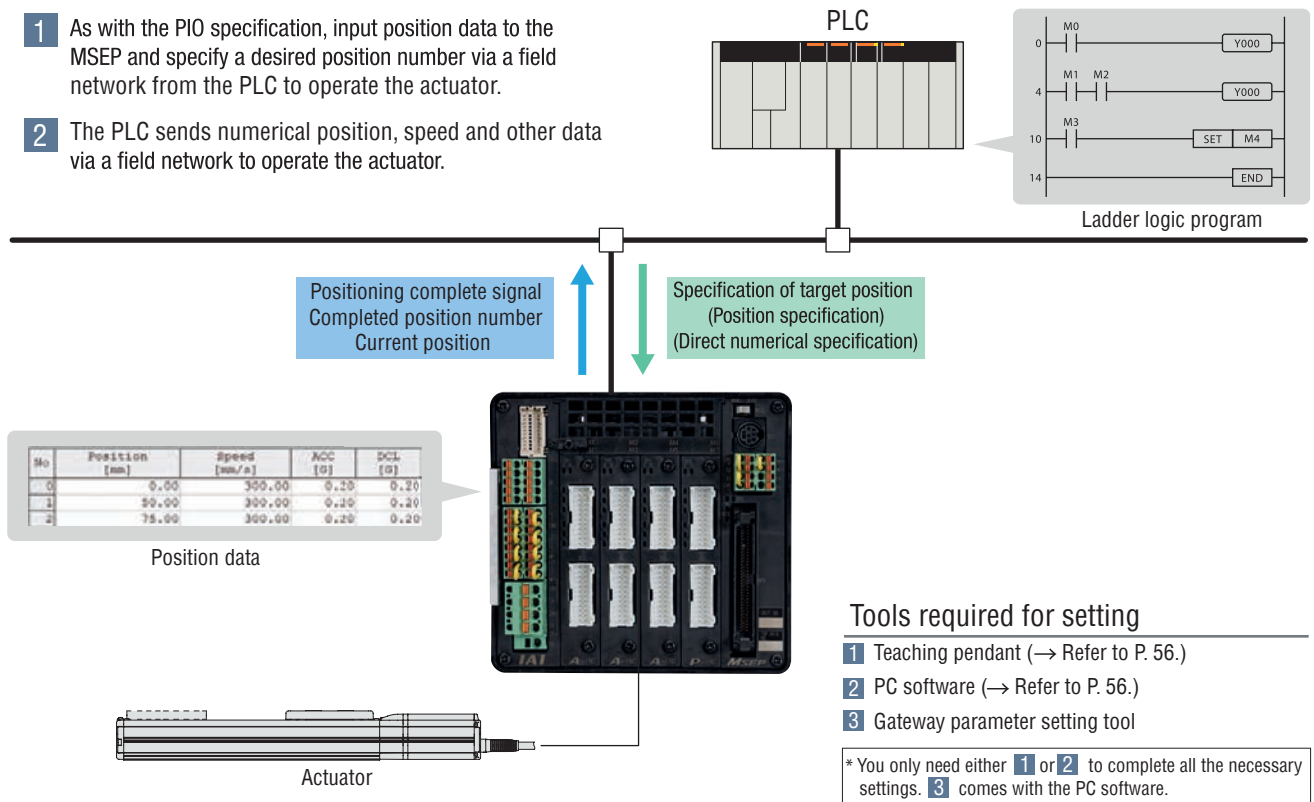

# How to Operate the MSEP-LC (\*)

(\*) MSEP-LC coming soon with CE conformity.

## PIO Specification

The MSEP-LC runs a ladder logic program internally to operate the axis and control the PIO I/O signals. The axis can be operated either by using position data or specifying coordinates directly.

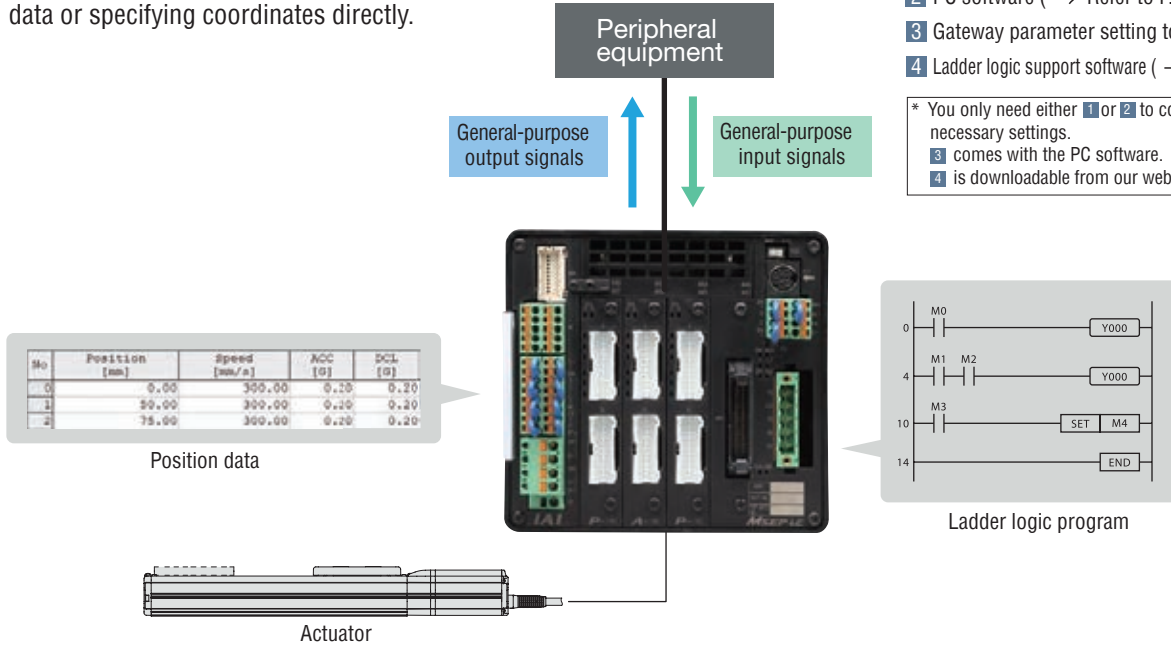

## Tools required for setting

- 1 Teaching pendant ( → Refer to P. 56.)
- 2 PC software ( → Refer to P. 56.)
- 3 Gateway parameter setting tool
- 4 Ladder logic support software ( → Refer to P. 48.)

\* You only need either 1 or 2 to complete all the necessary settings.  
 3 comes with the PC software.  
 4 is downloadable from our website. [Available Soon](#)

## Field Network Specification

The MSEP-LC runs a ladder logic program internally to operate the axis and control I/O signals via a network. The axis can be operated either by using position data or specifying coordinates directly.

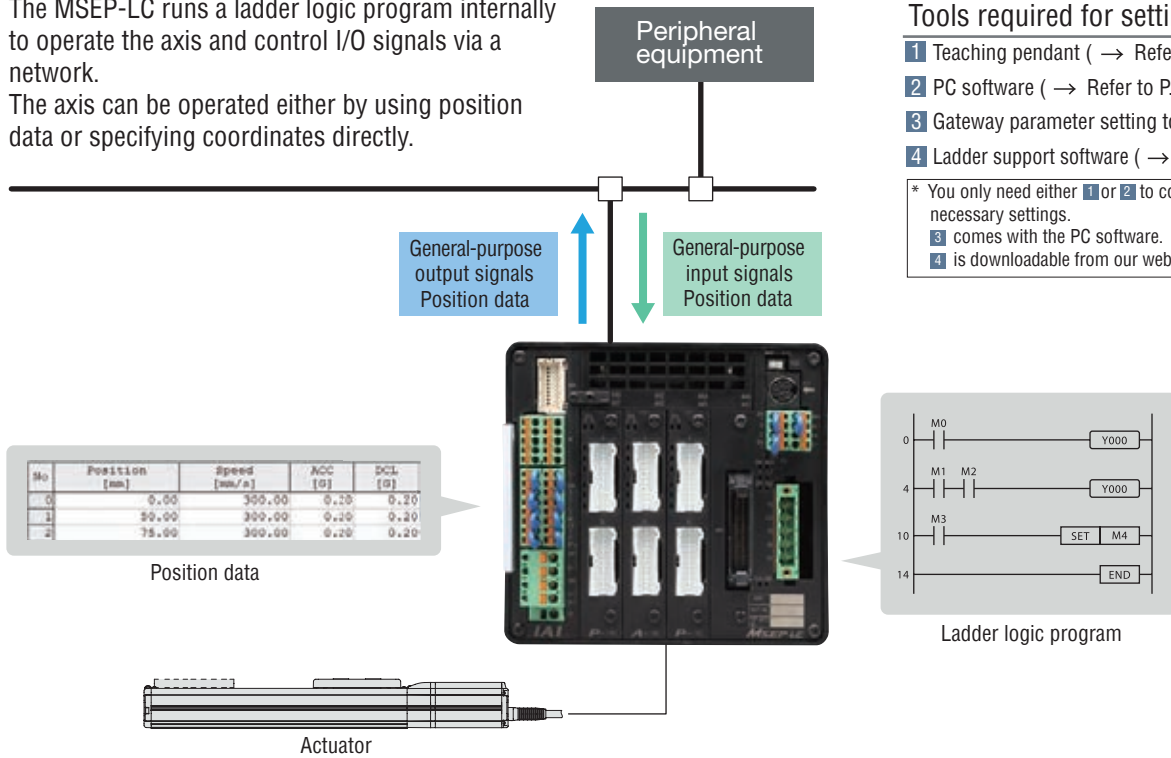

## Tools required for setting

- 1 Teaching pendant ( → Refer to P. 56.)
- 2 PC software ( → Refer to P. 56.)
- 3 Gateway parameter setting tool
- 4 Ladder support software ( → Refer to P. 48.)

\* You only need either 1 or 2 to complete all necessary settings.  
 3 comes with the PC software.  
 4 is downloadable from our website. [Available Soon](#)

Controller <MSEP-C/LC> **RCP5** series

## Names of the MSEP Controller Components

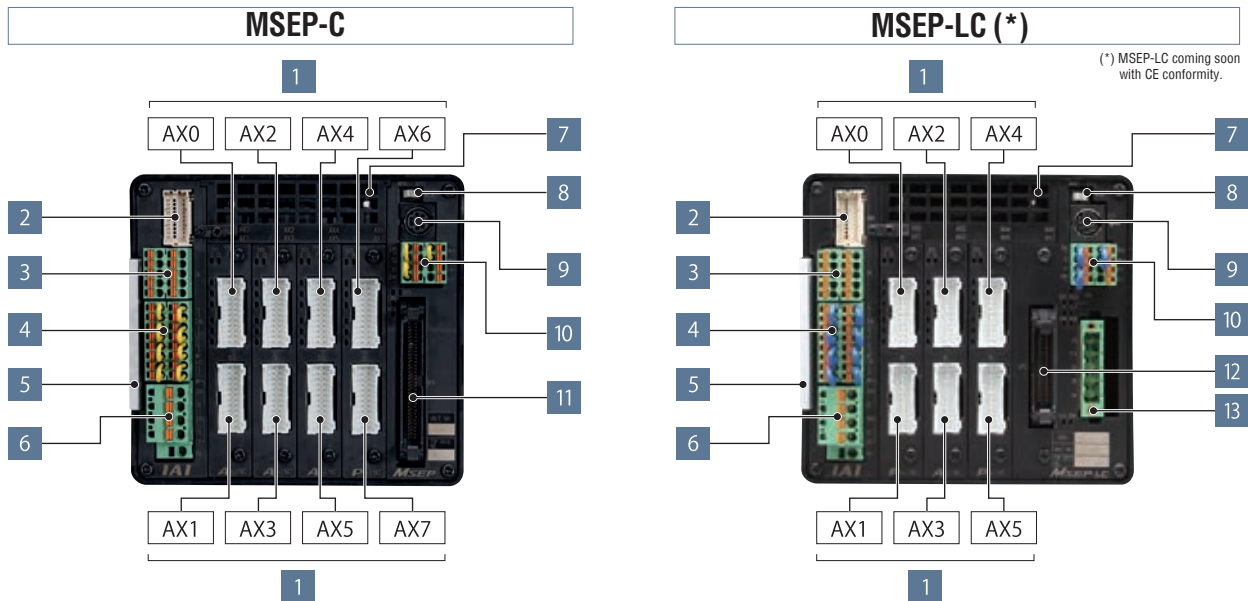

**Caution: With the high-output setting specification (PowerCon), only one axis can be connected per slot.**

## Descriptions of the components

- 1 Motor-encoder connectors for the actuator connection**  
Connect motor-encoder cable to the actuator
- 2 Connector for the absolute data backup battery**  
Connect the absolute data backup battery if the controller has the absolute position encoder specification
- 3 Connector for the external brake input**  
The connector to input a signal to release the brake for the actuator externally.
- 4 Connector for the emergency stop input for power source shut-off**  
The emergency stop input connector to connect in/output terminal of the external relay of the motor drive shut-off and each driver slot (\*1).
- 5 Information card for configuration of the connecting axes**  
The information card contains information regarding the configuration of the controller axes which is removable to examine the contents.
- 6 +24 V power source input connector**  
The main power source connector for the controller: Motor drive source shut-down is possible while restoring the power source for the controller unit in case of an emergency shut-down; This is because the terminals for the power source of the motor and the controller are separate.
- 7 Fan unit**  
Easily replaceable fan unit. (Replacement fan unit: Model MSEP-FU)
- 8 AUTO/MANUAL switch**  
To switch automatic operation to/from manual operation
- 9 SIO connector**  
To connect teaching box and the connecting cable for PC software
- 10 System I/O connector**  
The connector for remote AUTO/MANU switch input and emergency stop input for the entire controller with functions including an external regeneration-resistance expansion terminal.
- 11 PIO connector/ field network connection connector (MSEP-C only)**  
The PIO specification - connects to a 68-pin ribbon I/O cable.  
The field network specification - connects to a field network type specified on the MSEP controller.
- 12 Standard I/Os (MSEP-LC only) (\*)** (\*) MSEP-LC coming soon with CE conformity.  
The MSEP-LC comes installed with a 40-pin PIO connector as standard equipment.
- 13 Expansion I/Os (MSEP-LC only) (\*)** (\*) MSEP-LC coming soon with CE conformity.  
Expansion I/Os can be installed as an option.  
Available I/O types include PIO, DeviceNet, CC-Link, PROFIBUS-DP, CompoNet, Ethernet/IP, EtherCAT and PROFINET-IO.

(\*1) The shut-off feature is available on a single slot basis which is for two axes per slot. Please note that a single axis basis cannot be accommodated.

## Input/Output (PIO) Signals

The MSEP-C has dedicated inputs and outputs set to PIO signals at 34 input points/34 output points. The axis operates when each signal is turned ON/OFF from the host PLC.

With the MSEP-LC, general-purpose input/output signals at 32 input points/32 output points can be used in a ladder logic program by using the standard 16 input points/16 output points plus expansion I/Os.

### MSEP-C (PIO specification)

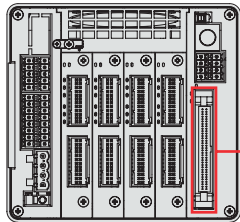

PIO connector

### MSEP-LC (Expansion I/O specification) (\*)

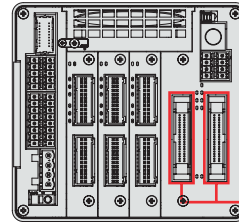

(\*) MSEP-LC coming soon with CE conformity.

PIO connector

### PIO Wiring Diagram for MSEP-C

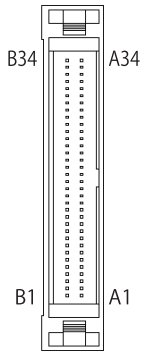

Connector name: HIF6-68PA-1.27DS (Hirose Electric)					
Pin No.	Category	Signal ID	Pin No.	Category	Signal ID
A1	24V	For I/O	A18		OUT0
A2	Input (Axis No. 0)	IN0	A19	Output (Axis No. 0)	OUT1
A3		IN1	A20		OUT2
A4		IN2	A21		OUT3
A5		IN3	A22		OUT4
A6	Input (Axis No. 1)	IN4	A23	Output (Axis No. 1)	OUT5
A7		IN5	A24		OUT6
A8		IN6	A25		OUT7
A9		IN7	A26		OUT8
A10	Input (Axis No. 2)	IN8	A27	Output (Axis No. 2)	OUT9
A11		IN9	A28		OUT10
A12		IN10	A29		OUT11
A13		IN11	A30		OUT12
A14	Input (Axis No. 3)	IN12	A31	Output (Axis No. 3)	OUT13
A15		IN13	A32		OUT14
A16		IN14	A33		OUT15
A17		IN15	A34		OV

Connector name: HIF6-68PA-1.27DS (Hirose Electric)					
Pin No.	Category	Signal ID	Pin No.	Category	Signal ID
B1	24V	For I/O	B18		OUT16
B2	Input (Axis No. 4)	IN16	B19	Output (Axis No. 4)	OUT17
B3		IN17	B20		OUT18
B4		IN18	B21		OUT19
B5		IN19	B22		OUT20
B6	Input (Axis No. 5)	IN20	B23	Output (Axis No. 5)	OUT21
B7		IN21	B24		OUT22
B8		IN22	B25		OUT23
B9		IN23	B26		OUT24
B10	Input (Axis No. 6)	IN24	B27	Output (Axis No. 6)	OUT25
B11		IN25	B28		OUT26
B12		IN26	B29		OUT27
B13		IN27	B30		OUT28
B14	Input (Axis No. 7)	IN28	B31	Output (Axis No. 7)	OUT29
B15		IN29	B32		OUT30
B16		IN30	B33		OUT31
B17		IN31	B34		OV

### PIO Wiring Diagram for MSEP-LC (\*)

(\*) MSEP-LC coming soon with CE conformity.

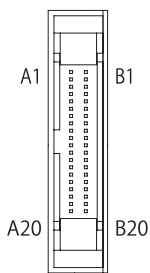

#### Standard I/Os

Pin No.	Category	Assigned memory	Pin No.	Category	Assigned memory
A1	Input	+24-V external input	A11	Input	X006
A2		Not used	A12		X007
A3		Not used	A13		X008
A4		Not used	A14		X009
A5		X000	A15		X00A
A6		X001	A16		X00B
A7		X002	A17		X00C
A8		X003	A18		X00D
A9		X004	A19		X00E
A10		X005	A20		X00F

Pin No.	Category	Assigned memory	Pin No.	Category	Assigned memory
B1	Output	Y000	B11	Output	Y00A
B2		Y001	B12		Y00B
B3		Y002	B13		Y00C
B4		Y003	B14		Y00D
B5		Y004	B15		Y00E
B6		Y005	B16		Y00F
B7		Y006	B17		Not used
B8		Y007	B18		Not used
B9		Y008	B19		0 V external input
B10		Y009	B20		

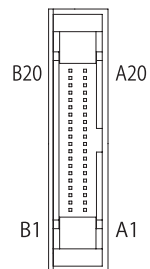

#### Expansion I/Os

Pin No.	Category	Assigned memory	Pin No.	Category	Assigned memory
A1	Input	+24-V external input	A11	Input	X016
A2		Not used	A12		X017
A3		Not used	A13		X018
A4		Not used	A14		X019
A5		X010	A15		X01A
A6		X011	A16		X01B
A7		X012	A17		X01C
A8		X013	A18		X01D
A9		X014	A19		X01E
A10		X015	A20		X01F

Pin No.	Category	Assigned memory	Pin No.	Category	Assigned memory
B1	Output	Y010	B11	Output	Y01A
B2		Y011	B12		Y01B
B3		Y012	B13		Y01C
B4		Y013	B14		Y01D
B5		Y014	B15		Y01E
B6		Y015	B16		Y01F
B7		Y016	B17		Not used
B8		Y017	B18		Not used
B9		Y018	B19		0 V external input
B10		Y019	B20		

# Controller <MSEP-C/LC> **RCP5** series

## Table of General Specifications

Specification item	Description																																																								
Number of axes in the controller	8 axes MAX (MSEP-C), 6 axes MAX (MSEP-LC) (*) <small>(*) MSEP-LC coming soon with CE conformity.</small>																																																								
Controller/ Motor input power	DC24V ±10%																																																								
Brake power	0.15 A x Number of axes																																																								
Current consumption by control power	0.8A																																																								
Controller inrush current	5A MAX, under 30 ms																																																								
Motor consumption current	<table border="1"> <thead> <tr> <th rowspan="2">Servo motor type</th> <th rowspan="2">Rated ampere</th> <th colspan="2">Maximum</th> <th rowspan="2">Pulse motor type</th> <th rowspan="2">Rated ampere</th> <th rowspan="2">Maximum</th> </tr> <tr> <th>Energy saver</th> <th>Standard/Hi-accel./decel.</th> </tr> </thead> <tbody> <tr> <td>2W</td> <td>0.8A</td> <td></td> <td>4.6A</td> <td>20P</td> <td>1.0A</td> <td>2.0A</td> </tr> <tr> <td>3W(RCD)</td> <td>0.7A</td> <td></td> <td>1.5A</td> <td>28P</td> <td>1.0A</td> <td>2.0A</td> </tr> <tr> <td>5W</td> <td>1.0A</td> <td></td> <td>6.4A</td> <td rowspan="2">35P</td> <td rowspan="2">2.2 A (high output disabled)</td> <td rowspan="2">2.2 A (high output disabled)</td> </tr> <tr> <td>10W(RCL)</td> <td>1.3A</td> <td></td> <td>6.4A</td> </tr> <tr> <td>10W(RCA/RCA2)</td> <td></td> <td>2.5A</td> <td>4.4A</td> <td rowspan="2">42P</td> <td rowspan="2">3.5 A (high output specification)</td> <td rowspan="2">4.2 A (high output specification)</td> </tr> <tr> <td>20W</td> <td>1.3A</td> <td>2.5A</td> <td>4.4A</td> </tr> <tr> <td>20 W (20S type)</td> <td>1.7A</td> <td>3.4A</td> <td>5.1A</td> <td rowspan="2">56P</td> <td rowspan="2"></td> <td rowspan="2"></td> </tr> <tr> <td>30W</td> <td>1.3A</td> <td>2.2A</td> <td>4.4A</td> </tr> </tbody> </table>	Servo motor type	Rated ampere	Maximum		Pulse motor type	Rated ampere	Maximum	Energy saver	Standard/Hi-accel./decel.	2W	0.8A		4.6A	20P	1.0A	2.0A	3W(RCD)	0.7A		1.5A	28P	1.0A	2.0A	5W	1.0A		6.4A	35P	2.2 A (high output disabled)	2.2 A (high output disabled)	10W(RCL)	1.3A		6.4A	10W(RCA/RCA2)		2.5A	4.4A	42P	3.5 A (high output specification)	4.2 A (high output specification)	20W	1.3A	2.5A	4.4A	20 W (20S type)	1.7A	3.4A	5.1A	56P			30W	1.3A	2.2A	4.4A
	Servo motor type			Rated ampere	Maximum				Pulse motor type	Rated ampere	Maximum																																														
		Energy saver	Standard/Hi-accel./decel.																																																						
	2W	0.8A		4.6A	20P	1.0A	2.0A																																																		
	3W(RCD)	0.7A		1.5A	28P	1.0A	2.0A																																																		
	5W	1.0A		6.4A	35P	2.2 A (high output disabled)	2.2 A (high output disabled)																																																		
	10W(RCL)	1.3A		6.4A																																																					
	10W(RCA/RCA2)		2.5A	4.4A	42P	3.5 A (high output specification)	4.2 A (high output specification)																																																		
20W	1.3A	2.5A	4.4A																																																						
20 W (20S type)	1.7A	3.4A	5.1A	56P																																																					
30W	1.3A	2.2A	4.4A																																																						
Motor inrush current	Slot numbers x 10A MAX, under 5ms																																																								
Motor-encoder cable length	Maximum length 20m (note) for absolute position																																																								
Serial communication (SIO port: dedicated teaching)	RS485 1ch (Modbus protocol compatible) Speed 9.6 to 230.4kbps																																																								
External interface	PIO specification	PIO specification : DC24 V dedicated signal in/output; Maximum input of 4 points/axis; Maximum output of 4 points/axis; Maximum cable length 10 m																																																							
	Field network specification	DeviceNet, CC-Link, PROFIBUS-DP, PROFINET-IO, CompoNet, EtherCAT, EtherNet/IP																																																							
Data configuration and input method	PC software application, touch panel teaching pendant, gateway parameter configuration tool																																																								
Data retention memory	Restore the position data and parameter in non-volatile memory (unlimited input)																																																								
Positioning points	PIO specification: 2 or 3 points Field network specification: 256 points (no limited input for the simple numerical control and the direct numerical control) (Note) The number of designated positions vary depending on the parameter configuration with motion mode selection.																																																								
LED display (On the front panel)	LED for driver status, 8 LEDs (for each driver board) Status LED, 4 LEDs (PIO specification), 7 LEDs (Fieldbus specification)																																																								
Electromagnetic brake force release	Enable to force-release by transmitting a deactivation signal to each axis (DC24 V input).																																																								
Surge protection	Overcurrent protection (A cut-off semiconductor circuit is built-in on each slot)																																																								
Electric shock protection	Class I basic insulation																																																								
Insulation resistance	DC500V 10 MΩ																																																								
Weight	620 g with the absolute position encoder specification plus 1950 g absolute data backup battery (8-axis specification)																																																								
Cooling method	Forced- air cooling																																																								
Ambient operating temperature/humidity	0 to 40°C, under 85% RH (non-condensing)																																																								
International Protection code	IP20																																																								

## Exterior Dimensions

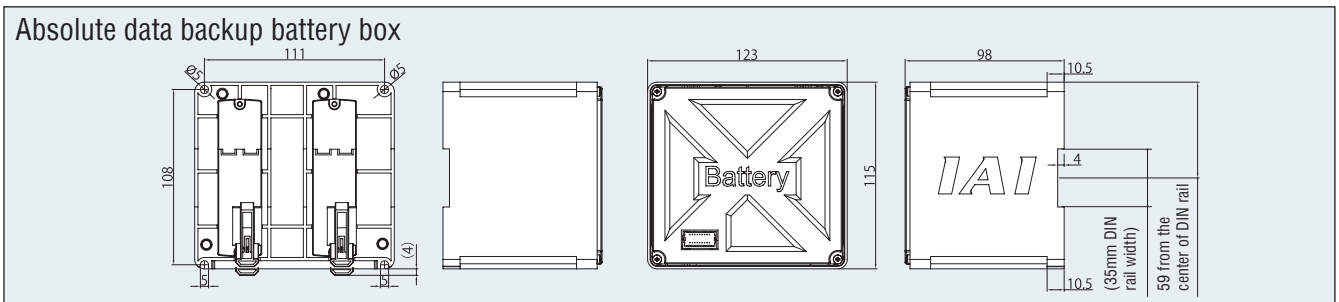
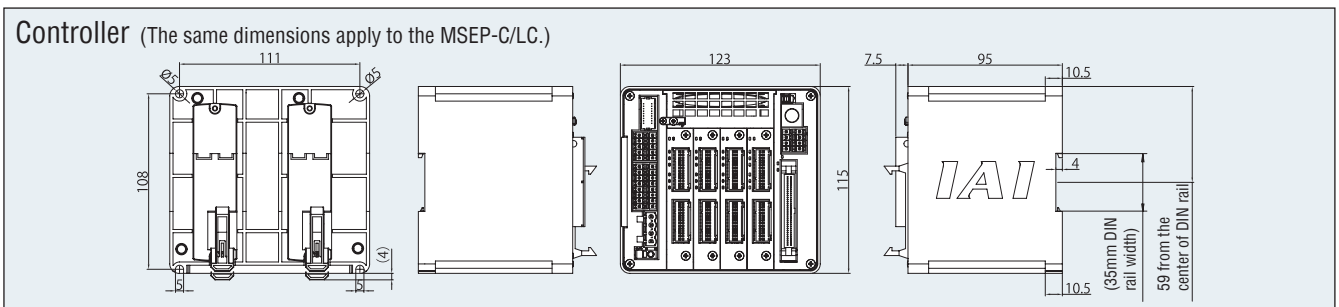



## Options

### Teaching pendant

**Summary** Teaching device for positioning input, test operation, and monitoring.

**Model** **TB-01-C (\*)** (\*) TB-01-C coming soon with CE conformity.

**Setting**



### Specification

Rated voltage	24V DC
Power consumption	3.6 W or less (150 mA or less)
Ambient operating temperature	0~50°
Ambient operating humidity	20 to 85%RH (non-condensing)
Environmental resistance	IP40 (initial state)
Weight	507 g (TB-01 unit only)

### PC software (Windows only) \* For the MSEP field network specification, the PC software is required.

**Summary** A startup support software for inputting positions, performing test runs, and monitoring. With enhancements for adjustment functions, the startup time is shortened.

**Model** **RCM-101-MW** (External device communication cable + RS232 conversion unit)

**Setting**

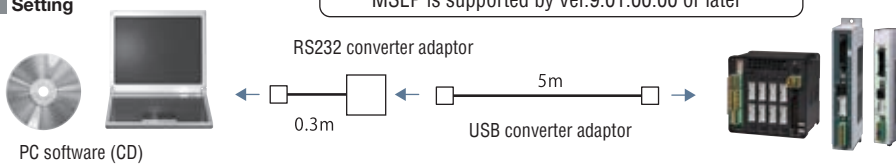

Supported Windows: 2000 SP4 or later / XP SP2 or later / Vista / 7



**Model** **RCM-101-USB** (External device communication cable + USB converter adaptor + USB cable)

**Setting**

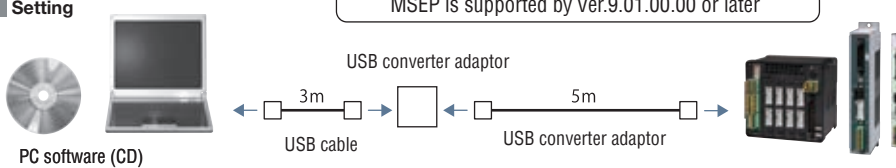

### External regeneration resistor

**Summary** The regeneration resistor converts regenerated current dissipated during deceleration of the motor load into heat. The MSEP controller has an internal regeneration resistor for ordinary operations, however, depending on the operational condition, please install an external regeneration resistor if the internal regeneration resistor capacity is insufficient.

**Model** **RER-1**

**Exterior dimensions**

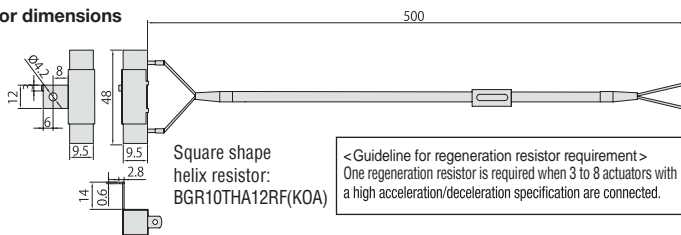

### Driver board

**Summary** A supplement or modification to the driver board is feasible with the MSEP controller. When the actuator that control motions needs to be modified, just replacing the driver board would serve the purpose without changing the entire controller. (The parameters need to be adjusted when changing the driver board)

**Model**

Motor type	High output type	Encoder type	Number of axes	Model
Pulse motor	High output setting	Battery-less absolute/incremental	1-axis	MSEP-PPD1-W
		Simple absolute	1-axis	MSEP-PPD1-A
	Cancellation of high output setting	Battery-less absolute/incremental	1-axis	MSEP-PD1-W
		Simple absolute	2-axis	MSEP-PD2-W
AC servo motor	—	Incremental	1-axis	MSEP-AD1-I
		Simple absolute	2-axis	MSEP-AD2-I
	—	Incremental	1-axis	MSEP-AD1-A
		Simple absolute	2-axis	MSEP-AD2-A
DC servo motor	—	Incremental	1-axis	MSEP-DD1-I
		Incremental	2-axis	MSEP-DD2-I

### Box for the absolute data backup battery

**Summary** If the absolute position encoder specification is selected with code ABB, the absolute data backup battery box is included with the controller. However, if the battery box is ordered as a separate unit, it does not include the battery but just the box itself. If the battery is needed, please purchase it separately. (Model: AB-7).

**Model** **MSEP-ABB** (Batteries not included)

**Exterior dimensions** See P.55

\* A cable (Model CB-MSEP-AB005) that connects the absolute data backup battery box to the MSEP is included with the box.

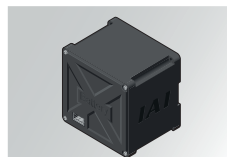

### Replacement battery

**Summary** The replacement battery for the absolute data backup battery box.

**Model** **AB-7**

### Replacement fan unit

**Model** **MSEP-FU**



# Service parts **RCP5** series

## Service parts

<b>Model number</b>	<b>CB-CAN-MPA</b> <input type="checkbox"/> <input type="checkbox"/> <input type="checkbox"/>	<b>Integrated Motor-Encoder Cable</b>	<b>for RCP5/RCD</b>
	<b>CB-CAN-MPA</b> <input type="checkbox"/> <input type="checkbox"/> <input type="checkbox"/> <b>-RB</b>	<b>Integrated Motor-Encoder Robot Cable</b>	

\* Please indicate cable length (L) in , maximum 20m. e.g.) 080=8m

(Front view) Actuator side

(Front view) Controller side

Pin No	Signal name	Pin No	Signal name
3	ØA	1	ØA
5	VMM	2	VMM
10	ØB	3	ØB
9	VMM	4	VMM
4	Ø A	5	Ø A
15	Ø B	6	Ø B
8	LS+	7	LS+
14	LS-	8	LS-
12	SA(mABS)	11	SA(mABS)
17	SB(mABS)	12	SB(mABS)
1	A+	13	A+
6	A-	14	A-
11	B+	15	B+
16	B-	16	B-
20	BK+	9	BK+
2	BK-	10	BK-
21	VCC	17	VCC
7	GND	19	GND
18	VPS	18	VPS
13	LS_GND	20	LS_GND
19	—	22	—
22	—(CFvcc)	21	—(CFvcc)
23	—	23	—
24	FG	24	FG

Minimum bending radius 5m or less length R = 68mm or more (for moving parts)  
 Longer than 5m R = 73mm or more (for moving parts)

\* The robot cable is designed for flex-resistance: Please use the robot cable if the cable has to be installed through the cable track.

(Note 1) If the cable is 5m or longer, Ø9.1 cable diameter applies for a non-robot cable and Ø10 for a robot cable.

<b>Model number</b>	<b>CB-CFA3-MPA</b> <input type="checkbox"/> <input type="checkbox"/> <input type="checkbox"/>	<b>Integrated Motor-Encoder Cable</b>	<b>for RCP5-RA8C/8R/10C/10R</b>
	<b>CB-CFA3-MPA</b> <input type="checkbox"/> <input type="checkbox"/> <input type="checkbox"/> <b>-RB</b>	<b>Integrated Motor-Encoder Robot Cable</b>	

\* Please indicate cable length (L) in , maximum 20m. e.g.) 080=8m

(Front view) Actuator side

(Front view) Controller side

Pin No	Signal name	Pin No	Signal name
A1	Ø A	1	Ø A
B1	VMM	2	VMM
A2	Ø A	5	Ø A
B2	Ø B	3	Ø B
A3	VMM	4	VMM
B3	Ø B	6	Ø B
A4	LS+	7	LS+
B4	LS-	8	LS-
A6	SA(mABS)	11	SA(mABS)
B6	SB(mABS)	12	SB(mABS)
A7	A+	13	A+
B7	A-	14	A-
A8	B+	15	B+
B8	B-	16	B-
A5	BK+	9	BK+
B5	BK-	10	BK-
A9	LS_GND	20	LS_GND
B9	VPS	18	VPS
A10	VCC	17	VCC
B10	GND	19	GND
A11	—	21	—
B11	FG	24	FG

Minimum bending radius 5m or less length R = 68mm or more (for moving parts)  
 Longer than 5m R = 73mm or more (for moving parts)

\* The robot cable is designed for flex-resistance: Please use the robot cable if the cable has to be installed through the cable track.

(Note 1) If the cable is 5m or longer, Ø9.1 cable diameter applies for a non-robot cable and Ø10 for a robot cable.

<b>Model number</b>	<b>CB-CA-MPA</b> <input type="checkbox"/> <input type="checkbox"/> <input type="checkbox"/>	<b>Integrated Motor-Encoder Cable</b>	<b>for RCP4</b>
	<b>CB-CA-MPA</b> <input type="checkbox"/> <input type="checkbox"/> <input type="checkbox"/> <b>-RB</b>	<b>Integrated Motor-Encoder Robot Cable</b>	

\* Please indicate cable length (L) in , maximum 20m. e.g.) 080=8m

(Front view) Actuator side

(Front view) Controller side

Pin No	Signal name	Pin No	Signal name
A1	ØA/U	1	Ø A/U
B1	VMM/V	2	VMM/V
A2	Ø A/W	5	Ø A/W
B2	Ø B/-	3	Ø B/-
A3	VMM/-	4	VMM/-
B3	Ø B/+	6	Ø B/+
A4	LS+/BK+	7	LS+/BK+
B4	LS-/BK-	8	LS-/BK-
A6	-/A+	11	-/A+
B6	-/A-	12	-/A-
A7	A+/B+	13	A+/B+
B7	A-/B-	14	A-/B-
A8	B+/Z+	15	B+/Z+
B8	B-/Z-	16	B-/Z-
A5	BK+/LS+	9	BK+/LS+
B5	BK-/LS-	10	BK-/LS-
A9	LS_GND	20	LS_GND
B9	VPS	18	VPS
A10	VCC	17	VCC
B10	GND	19	GND
A11	—	21	—
B11	FG	24	FG

Minimum bending radius 5m or less length R = 68mm or more (for moving parts)  
 Longer than 5m R = 73mm or more (for moving parts)

\* The robot cable is designed for flex-resistance: Please use the robot cable if the cable has to be installed through the cable track.

(Note 1) If the cable is 5m or longer, Ø9.1 cable diameter applies for a non-robot cable and Ø10 for a robot cable.

<b>Model number</b>	<b>CB-APSEP-MPA</b> <input type="checkbox"/> <input type="checkbox"/> <input type="checkbox"/> <b>-LC</b>	<b>Integrated Motor-Encoder Cable</b>	<b>for RCP3/RCA2 and others</b>
	<b>CB-APSEP-MPA</b> <input type="checkbox"/> <input type="checkbox"/> <input type="checkbox"/>	<b>Integrated Motor-Encoder Robot Cable</b>	

\* Please indicate cable length (L) in , maximum 20m. e.g.) 080=8m

(Front view) Actuator side

(Front view) Controller side

Actuator side Pin number	Signal name	Controller side Pin number
A1	(ØA)(U)	1
B1	(VMM)(V)	2
A2	(ØA)(W)	5
B2	(ØB)(-)	3
A3	(VMM)(-)	4
B3	(ØB)(+)	6
A4	(LS+)(BK+)	7
B4	(LS-)(BK-)	8
A6	(-)(A+)	11
B6	(-)(A-)	12
A7	(A+)(B+)	13
B7	(A-)(B-)	14
A8	(B+)(Z+)	15
B8	(B-)(Z-)	16
A5	(BK+)(LS+)	9
B5	(BK-)(LS-)	10
A9	(GND)(LS)	20
B9	(VPS)(VPS)	18
A10	(VCC)(VCC)	17
B10	(GND)(GND)	19
A11	NC	21
B11	Shield (FG) (FG)	24
	NC	23

Minimum bending radius R = 68mm or more (for moving parts)

\* The robot cable is designed for flex-resistance: Please use the robot cable if the cable has to be installed through the cable track.

**Model number** **CB-PSEP-MPA**  **Integrated Motor-Encoder Robot Cable** **for RCP2**

\* Please indicate cable length (L) in , maximum 20m. e.g.) 080=8m

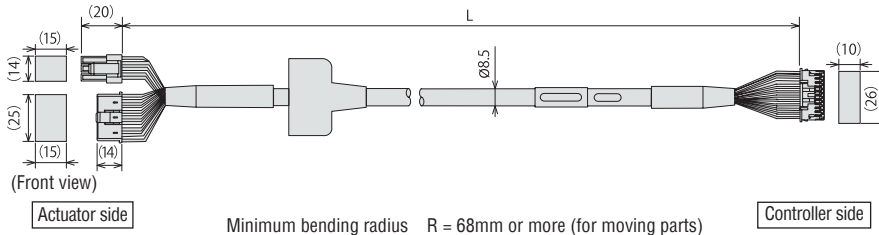

Minimum bending radius R = 68mm or more (for moving parts)

Actuator side Pin number		Controller side Pin number
1	[ØA]	1
2	[VMM]	2
4	[ØB]	3
5	[VMM]	4
3	[ØA]	5
6	[ØB]	6
16	[BK+]	9
17	[BK-]	10
5	NC	11
6	NC	12
13	[LS+]	7
14	[LS-]	8
1	[A+]	13
2	[A-]	14
4	[B+]	15
4	[B-]	16
10	[VCC]	17
13	[VPS]	18
9	[GND]	19
12	[Spae]	20
15	NC	21
7	NC	22
8	NC	23
18	Shield [FG]	24

**Model number** **CB-RPSEP-MPA**  **Integrated Motor-Encoder Robot Cable** **for RCP2-RTBS/RTBSL/RTCS/RTCSL**

\* Please indicate cable length (L) in , maximum 20m. e.g.) 080=8m

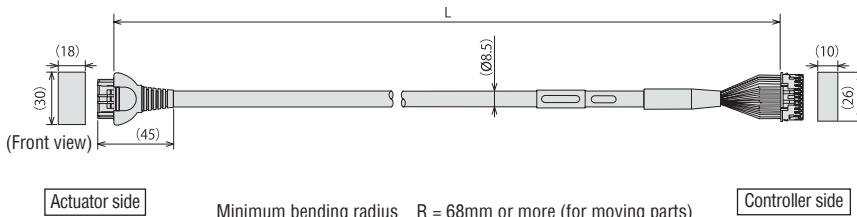

Minimum bending radius R = 68mm or more (for moving parts)

Actuator side Pin number		Controller side Pin number
A1	[ØA]	1
B1	[VMM]	2
A2	[ØA]	5
B2	[ØB]	3
A3	[VMM]	4
B3	[ØB]	6
A6	[LS+]	7
B6	[LS-]	8
A7	[A+]	13
B7	[A-]	14
A8	[B+]	15
B8	[B-]	16
A4	NC	—
B4	NC	—
A5	NC	9
B5	[BK-]	10
A9	[GNDLS]	20
B9	[VCC]	17
A10	[VCC]	18
B10	[GND]	19
A11	NC	21
B11	NC	22
	Shield [FG] (FG)	24
	NC	23

**Model number** **CB-ASEP-MPA**  **Integrated Motor-Encoder Robot Cable** **for RCA**

\* Please indicate cable length (L) in , maximum 20m. e.g.) 080=8m

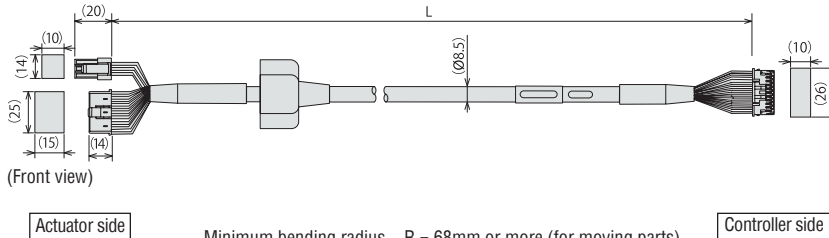

Minimum bending radius R = 68mm or more (for moving parts)

Actuator side Pin number		Controller side Pin number
1	[U]	1
2	[W]	2
	NC	3
3	NC	4
	[W]	5
	NC	6
18	[BK+]	7
17	[BK-]	8
7	[LS+]	9
16	[LS-]	10
1	[A+]	11
2	[A-]	12
3	[B+]	13
4	[B-]	14
10	[Z+]	15
11	[Z-]	16
14	[VCC]	17
13	[VPS]	18
15	[GND]	19
6	[Spae]	20
5	NC	21
8	NC	22
12	NC	23
9	Shield [FG]	24

**Model number** **CB-MSEP-PIO**  **PIO Flat Cable** **for MSEP-C**

\* Please indicate cable length (L) in , maximum 10m. e.g.) 020=2m

HIF6-068D-1.27R

No.	Cable color	Wiring	No.	Cable color	Wiring	No.	Cable color	Wiring	No.	Cable color	Wiring
A1	Brown-1		A18	Gray-2		B1	Brown-5		B18	Gray-6	
A2	Red-1		A19	White-2		B2	Red-5		B19	White-6	
A3	Orange-1		A20	Black-2		B3	Orange-5		B20	Black-6	
A4	Yellow-1		A21	Brown-3		B4	Yellow-5		B21	Brown-7	
A5	Green-1		A22	Red-3		B5	Green-5		B22	Red-7	
A6	Blue-1		A23	Orange-3		B6	Blue-5		B23	Orange-7	
A7	Purple-1		A24	Yellow-3		B7	Purple-5		B24	Yellow-7	
A8	Gray-1		A25	Green-3		B8	Gray-5		B25	Green-7	
A9	White-1		A26	Blue-3		B9	White-5		B26	Blue-7	
A10	Black-1		A27	Purple-3		B10	Black-5		B27	Purple-7	
A11	Brown-2		A28	Gray-3		B11	Brown-6		B28	Gray-7	
A12	Red-2		A29	White-3		B12	Red-6		B29	White-7	
A13	Orange-2		A30	Black-3		B13	Orange-6		B30	Black-7	
A14	Yellow-2		A31	Brown-4		B14	Yellow-6		B31	Brown-8	
A15	Green-2		A32	Red-4		B15	Green-6		B32	Red-8	
A16	Blue-2		A33	Orange-4		B16	Blue-6		B33	Orange-8	
A17	Purple-2		A34	Yellow-4		B17	Purple-6		B34	Yellow-8	

**Model number** **CB-PAC-PIO**  **PIO Flat Cable** **for PCON-CA/MSEP-LC**

\* Please indicate cable length (L) in , maximum 20m. e.g.) 080=8m

HIF6-40D-1.27R

No.	Signal name	Cable color	Wiring	No.	Signal name	Cable color	Wiring
A1	24V	Brown-1		B1	OUT0	Brown-3	
A2	24V	Red-1		B2	OUT1	Red-3	
A3	—	Orange-1		B3	OUT2	Orange-3	
A4	—	White-1		B4	OUT3	White-3	
A5	IN0	Green-1		B5	OUT4	Green-3	
A6	IN1	Blue-1		B6	OUT5	Blue-3	
A7	IN2	Purple-1		B7	OUT6	Purple-3	
A8	IN3	Gray-1		B8	OUT7	Gray-3	
A9	IN4	White-1		B9	OUT8	White-3	
A10	IN5	Black-1		B10	OUT9	Black-3	
A11	IN6	Brown-2		B11	OUT10	Brown-4	
A12	IN7	Red-2		B12	OUT11	Red-4	
A13	IN8	Orange-2		B13	OUT12	Orange-4	
A14	IN9	Yellow-2		B14	OUT13	Yellow-4	
A15	IN10	Green-2		B15	OUT14	Green-4	
A16	IN11	Blue-2		B16	OUT15	Blue-4	
A17	IN12	Purple-2		B17	—	Purple-4	
A18	IN13	Gray-2		B18	—	Gray-4	
A19	IN14	White-2		B19	0V	White-4	
A20	IN15	Black-2		B20	0V	Black-4	

# Actuator Options **RCP5** series

## Rod Installation Option

### Flange bracket

#### Option code FL

#### Applicable rod types

RCP5-RA4C/RA6C/RA7C/RA8C/RA8R/RA10C/RA10R

#### Flange Option code: FL

Item | A bracket that is used to secure a rod actuator from the actuator side.



#### RCP5-RA4C

Model number  
RCP5-FL-RA4

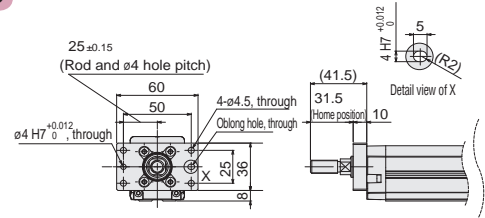

#### RCP5-RA6C

Model number  
RCP5-FL-RA6

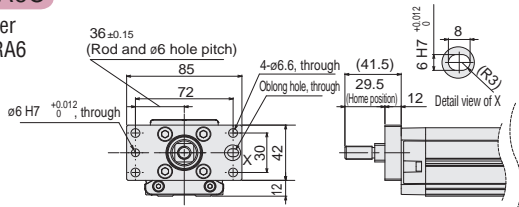

#### RCP5-RA7C

Model number  
RCP5-FL-RA7

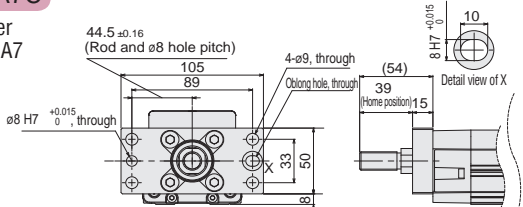

#### RCP5-RA8C/8R

Model number  
RCP5-FL-RA8

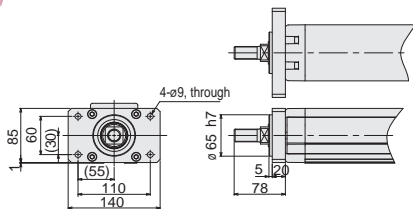

#### RCP5-RA10C/RA10R

Model number  
RCP5-FL-RA10

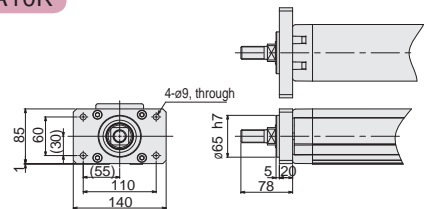

### Tip adapter (Flange)

#### Option code FFA

#### Applicable rod types

RCP5-RA4C/RA6C/RA7C

#### Tip adapter (Flange) Option code: FFA

Item | An adapter that is used to install jigs, etc. on the rod tip using four bolts.

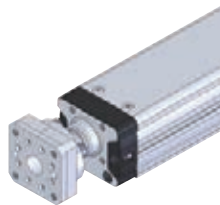

#### RCP5-RA4C

Model number  
RCP5-FFA-RA4

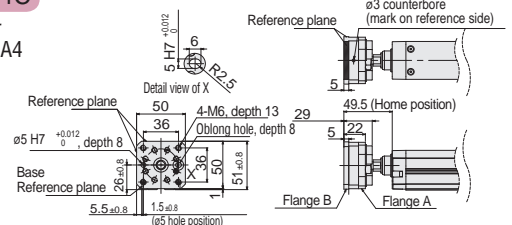

#### RCP5-RA6C

Model number  
RCP5-FFA-RA6

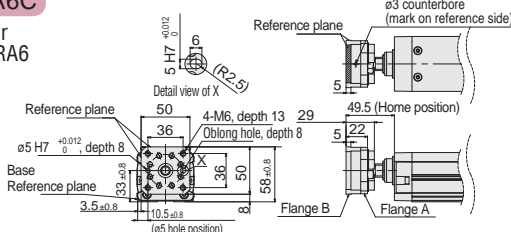

#### RCP5-RA7C

Model number  
RCP5-FFA-RA7

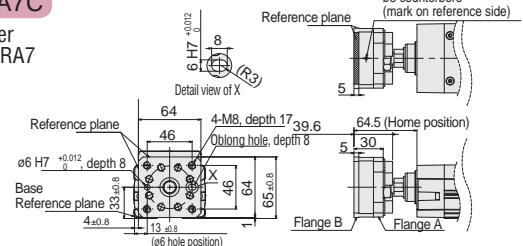

Tip adapter (Internal thread)

Option code NFA

Applicable rod types

RCP5-RA4C/RA6C/RA7C

Tip adapter (Internal thread)  
Option code: NFA

Item An adapter that is used to install jigs, etc. on the rod tip using a bolt.



RCP5-RA4C

Model number RCP5-NFA-RA4

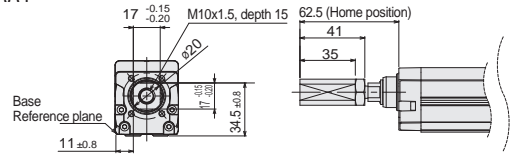

RCP5-RA6C

Model number RCP5-NFA-RA6

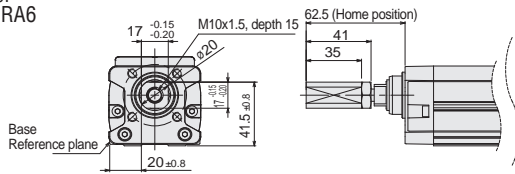

RCP5-RA7C

Model number RCP5-NFA-RA7

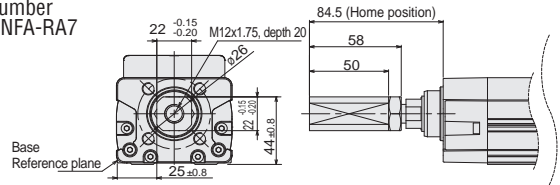

Tip adapter (Keyway)

Option code KFA

Applicable rod types

RCP5-RA4C/RA6C/RA7C

Tip adapter (Keyway)  
Option code: KFA

Item An adapter that is used to install jigs, etc. on the rod tip using a bolt and parallel key.



RCP5-RA4C

Model number RCP5-KFA-RA4

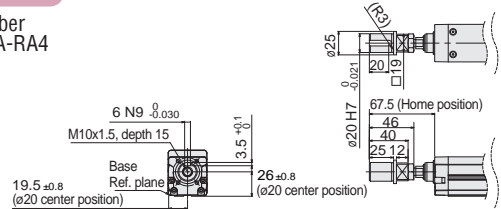

RCP5-RA6C

Model number RCP5-KFA-RA6

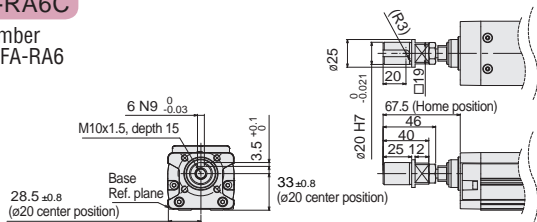

RCP5-RA7C

Model number RCP5-KFA-RA7

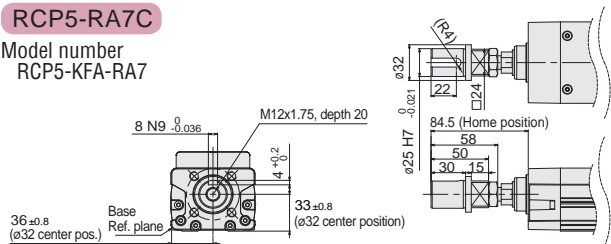

**RCP5 Series  
Slider / Rod Type  
Catalogue No. 0814-E**

The information contained in this catalog is subject to change without notice for the purpose of product improvement



**IAI Industrieroboter GmbH**

Ober der Röth 4  
D-65824 Schwalbach / Frankfurt  
Germany

Tel.: +49-6196-8895-0

Fax: +49-6196-8895-24

E-Mail: [info@IAI-GmbH.de](mailto:info@IAI-GmbH.de)

Internet: <http://www.eu.IAI-GmbH.de>

---

**IAI America, Inc.**

2690 W. 237th Street, Torrance, CA 90505, U.S.A  
Phone: +1-310-891-6015, Fax: +1-310-891-0815

**IAI (Shanghai) Co., Ltd**

Shanghai Jiahua Business Centee A8-303.808,  
Hongqiao Rd., Shanghai 200030, China  
Phone: +86-21-6448-4753, Fax: +86-21-6448-3992

**IAI CORPORATION**

645-1 Shimizu Hirose, Shizuoka 424-0102, Japan  
Phone: +81-543-64-5105, Fax: +81-543-64-5182

**IAI Robot (Thailand) Co., Ltd**

825 PhairojKijja Tower 12th Floor, Bangna-Trad RD.,  
Bangna, Bangna, Bangkok 10260, Thailand  
Phone: +66-2-361-4457, Fax: +66-2-361-4456